



Light-Duty Vehicle Technology Cost Analysis – European Vehicle Market (Phase 1)

Analysis Report BAV 10-449-001

Prepared for:

International Council on Clean Transportation

1225 I Street NW, Suite 900

Washington DC, 20005

<http://www.theicct.org/>

Submitted by:

Greg Kolwich

FEV, Inc.

4554 Glenmeade Lane

Auburn Hills, MI 48326

Phone: (248) 373-6000 ext. 2411

Email: kolwich@fev.com

May 17, 2012

Contents

Section	Page
A. Executive Summary	9
B. Introduction	16
B.1 Project Overview	16
B.2 Technologies Analyzed	18
B.2.1 Technologies Analyzed in the Phase 1 Analysis	18
B.2.2 Technologies Considered for the Phase 2 Analysis	18
B.3 Process Overview	19
B.3.1 EPA Project Costing Methodology	20
B.3.1.1 EPA Project Cost Methodology Overview	20
B.3.1.2 EPA Detailed Teardown Cost Analysis Process Overview	21
B.3.1.3 EPA Scaling of Cost Analysis Data to Alternative Vehicle Segments	27
B.3.2 ICCT Project Costing Process Overview	31
B.3.2.1 Cost Model Databases	34
B.3.2.2 Technology Configuration & Vehicle Segment Attribute Differences	36
B.4 Market Segment Comparison & Technology Overview	40
B.4.1 North American Market Analysis Overview	40
B.4.2 European Market Analysis Overview	43
B.5 Manufacturing Assumption Overview	45
B.6 Application of ICM Factor	48
B.7 Application of Learning Curve Factor	49
C. Database Updates	53
C.1 Database Update Overview	53
C.2 Material Database	54
C.2.1 Material Database Overview	54
C.2.2 Material Database Updates for European Analysis	56
C.3 Labor Database	58
C.3.1 Labor Database Overview	58

C.3.2	Labor Database Updates for European Analysis	59
C.4	Manufacturing Overhead (Burden) Database	60
C.4.1	Manufacturing Overhead Database Overview	60
C.4.2	Manufacturing Overhead Updates for European Analysis	62
C.5	Mark-Up Database	64
C.5.1	Mark-up Database Overview	64
C.5.2	Mark-Up Database Updates for European Analysis	66
C.6	Packaging Database	66
C.6.1	Packaging Database Overview	66
C.6.2	Packaging Database Updates for European Analysis	67
D.	Manufacturing Assumption and Quote Summary Worksheet & Cost Model Analysis Updates	68
D.1	Overview of MAQS Worksheet	68
D.2	Overview of MAQS Changes	68
D.3	Overview of CMAT	68
D.4	Overview of CMAT Changes	69
E.	Case Study Results	70
E.1	Engine Technology Configurations Evaluated	70
E.1.1	Engine Technology Overview	70
E.1.1.1	DS, TC, GDI Engines	70
E.1.1.2	Variable Valve Timing and Lift Valvetrain Technology	76
E.1.2	Engine Cost Analysis Overview	77
E.2	Transmission Technology Configurations Evaluated	82
E.2.1	Transmission Technology Overview	82
E.2.1.1	6-Speed Automatic Compared to 5-Speed Automatic Transmission	82
E.2.1.2	6-Speed Dual Clutch Transmission Compared to a 6-Speed Automatic Transmission	84
E.2.1.3	8-Speed Automatic Transmission compared to a 6-Speed Automatic Transmission	86
E.2.2	Transmission Cost Analysis Overview	88
E.3	Start-Stop HEV Technology Configuration Evaluated	91

E.3.1	Start-Stop HEV Technology Overview	91
E.3.2	Start-Stop HEV Cost Analysis Overview	92
E.4	Power-Split HEV Technology Configuration Evaluated	95
E.4.1	Power-Split HEV Technology Overview	95
E.4.1.1	Ford Fusion Power-Split HEV Technology Overview	95
E.4.1.2	Power-Split Assumption Differences for ICCT versus EPA Analysis	99
E.4.1.3	Scaling of Ford Fusion Results to European Case Studies	99
E.4.2	Power-Split HEV Cost Analysis Overview	100
E.5	P2 HEV Technology Configuration Evaluated	106
E.5.1	P2 HEV Technology Overview	106
E.5.1.1	P2 HEV Technology Configuration Overview	106
E.5.1.2	P2 Assumption Similarities and Differences for the ICCT versus EPA Analysis	107
E.5.1.3	Scaling of Ford Fusion Results to European Case Studies	108
E.5.2	P2 HEV Cost Analysis Overview	109
E.6	Electrical Air Conditioning Compressor Technology Configuration Evaluated	115
E.6.1	Electrical Air Conditioning Compressor Technology Overview	115
E.6.2	Electrical Air Compressor Cost Analysis Overview	116
F.	Sensitivity Analysis	119
G.	Appendix	121
G.1	Vehicle Segment Attribute Database Summary File Cost Model Inputs	122
G.2	Main Sections of Manufacturing Assumption and Quote Summary Worksheet	128
H.	Glossary of Terms	134

List of Appendices

Number	Page
G.1 Vehicle Segment Attribute Database Summary File Cost Model Inputs.....	122
G.2 Main Sections of Manufacturing Assumption and Quote Summary Worksheet.....	128

Figures

NUMBER	PAGE
FIGURE B-1: PROCESS OVERVIEW FOR CONVERTING EPA NORTH AMERICAN MARKET NET INCREMENTAL DIRECT MANUFACTURING COSTS TO EUROPEAN MARKET NET INCREMENTAL COSTS	17
FIGURE B-2: SAMPLE OF COMPONENTS REMOVED DURING HIGH LEVEL TEARDOWN OF FUEL INDUCTION SYSTEM ..	22
FIGURE B-3: INITIAL LEVEL OF INJECTOR TEARDOWN	23
FIGURE B-4: COST ANALYSIS PROCESS FLOW STEPS AND DOCUMENT INTERACTION (PART 1)	25
FIGURE B-5: COST ANALYSIS PROCESS FLOW STEPS AND DOCUMENT INTERACTION (PART 2)	26
FIGURE B-6: ILLUSTRATION OF BILL OF MATERIAL STRUCTURE USED IN COST ANALYSIS	27
FIGURE B-7: PROCESS STEP OVERVIEW FOR SCALING INCREMENTAL DIRECT MANUFACTURING COSTS TO ALTERNATIVE VEHICLE SEGMENTS	30
FIGURE B-8: ICCT PROJECT COSTING METHODOLOGY	33
FIGURE B-9: ILLUSTRATION SHOWING THE SIMILARITIES AND DIFFERENCES BETWEEN A US AND GERMANY COST MODEL FOR THE SAME MANUFACTURING OPERATION	36
FIGURE B-10: LEARNING CURVE FACTORS APPLIED IN EUROPEAN ANALYSIS	51
FIGURE B-11: LEARNING CURVE FACTOR APPLICATION EXAMPLE	52
FIGURE C-2: BURDEN RATE CALCULATOR EXCERPT - PRIMARY EQUIPMENT SECONDARY CONTRIBUTIONS (U.S. ANALYSIS DEFAULT VALUES)	62
FIGURE C-3: UTILITY COSTS USED IN EPA NORTH AMERICAN ANALYSIS	63
FIGURE C-4: UTILITY COSTS USED IN ICCT EUROPE ANALYSIS	63
FIGURE E-1: MULTIAIR HARDWARE ILLUSTRATION	76
FIGURE E-2: SATURN VUE GREEN LINE PRIMARY BAS TECHNOLOGY CONFIGURATION	92
FIGURE E-3: POWER-SPLIT SYSTEM BOUNDARY ILLUSTRATION	97
FIGURE E-4: P2 SYSTEM BOUNDARY ILLUSTRATION	107
FIGURE E-5: BELT-DRIVEN COMPRESSOR AND MOUNTING HARDWARE	115
FIGURE E-6: ELECTRIC COMPRESSOR AND MOUNTING HARDWARE	116
FIGURE F-1: EASTERN EUROPE LABOR RATE AVERAGES RELATIVE TO GERMANY	119
FIGURE G-1: SAMPLE MAQS COSTING WORKSHEET (PART 1 OF 2)	129
FIGURE G-2: SAMPLE MAQS COSTING WORKSHEET (PART 2 OF 2)	130
FIGURE G-3: EXCERPT ILLUSTRATING AUTOMATED LINK BETWEEN OEM/T1 CLASSIFICATION INPUT IN MAQS WORKSHEET AND THE CORRESPONDING MARK-UP PERCENTAGES UPLOADED FROM THE MARK-UP DATABASE	131
FIGURE G-4: EXAMPLE OF PACKAGING COST CALCULATION FOR BASE BATTERY MODULE	133

Tables

Number	Page
TABLE A-1: ADVANCED INTERNAL COMBUSTION ENGINE TECHNOLOGY CONFIGURATIONS EVALUATED	11
TABLE A-2: ADVANCE TRANSMISSION TECHNOLOGY CONFIGURATIONS EVALUATED	11
TABLE A-3: ADVANCE START-STOP HYBRID ELECTRIC VEHICLE TECHNOLOGY CONFIGURATION EVALUATED (BELT ALTERNATOR GENERATOR ARCHITECTURE)	12
TABLE A-4: POWER-SPLIT HYBRID ELECTRIC VEHICLE TECHNOLOGY CONFIGURATION	13
TABLE A-5: P2 HYBRID ELECTRIC VEHICLE TECHNOLOGY CONFIGURATION	14
TABLE A-6: ELECTRICAL AIR CONDITIONING COMPRESSOR TECHNOLOGY CONFIGURATION	15
TABLE B-1: STUDIED TECHNOLOGY CONFIGURATIONS APPLICABILITY TO NORTH AMERICAN AND EUROPEAN VEHICLE SEGMENTS	39
TABLE B-2: EPA NORTH AMERICAN POWERTRAIN VEHICLE CLASS SUMMARY MATRIX (P-VCSM)	41
TABLE B-3: EPA PUBLISHED REPORTS FOR EVALUATED TECHNOLOGY CONFIGURATIONS.....	42
TABLE B-4: EUROPEAN POWERTRAIN VEHICLE CLASS SUMMARY MATRIX (P-VCSM)	44
TABLE B-5: UNIVERSAL CASE STUDY ASSUMPTION UTILIZED IN EUROPEAN ANALYSIS	46
TABLE B-6: INDIRECT COST MULTIPLIERS (ICMS) USED IN EUROPEAN ANALYSIS	49
TABLE E-1: 1.6L, I4, DS, TC, GDI ICE COMPARED TO 2.4L I4, NA, PFI, ICE HARDWARE OVERVIEW	73
TABLE E-2: 2.0L, I4, DS, TC, GDI ICE COMPARED TO 3.0L V6, NA, PFI ICE HARDWARE OVERVIEW	74
TABLE E-3: 3.5L, V6, DS, TC, GDI ICE COMPARED TO 5.4L, V8, NA, PFI ICE HARDWARE OVERVIEW	75
TABLE E-5: DOWNSIZED, TURBOCHARGED, GASOLINE DIRECT INJECT ICE INCREMENTAL DIRECT MANUFACTURING COST SUMMARY BY FUNCTION.....	79
TABLE E-7: APPLICATION OF INDIRECT COST MULTIPLIERS AND LEARNING CURVE FACTORS TO EVALUATED ENGINE TECHNOLOGIES (DS, TC, GDI ICE & VVTL).....	81
TABLE E-8: NET INCREMENTAL (DIRECT + INDIRECT) MANUFACTURING COSTS FOR EVALUATED ENGINE TECHNOLOGIES (DS, TC, GDI ICE & VVTL).....	81
TABLE E-9: 6-SPEED AT COMPARED TO 5-SPEED AT, HARDWARE OVERVIEW	83
TABLE E-10: 6-SPEED DSG/DCT COMPARED TO 6-SPEED AT, HARDWARE OVERVIEW	85
TABLE E-11: 8-SPEED AT COMPARED TO 6-SPEED AT, HARDWARE OVERVIEW	87
TABLE E-12: TRANSMISSION TECHNOLOGY CONFIGURATIONS, INCREMENTAL DIRECT MANUFACTURING COST SUBSYSTEM SUMMARY	89
TABLE E-13: APPLICATION OF INDIRECT COST MULTIPLIERS AND LEARNING CURVE FACTORS TO EVALUATED TRANSMISSION TECHNOLOGIES (6-SPEED AT, 8-SPEED AT, 6-SPEED DCT).....	90
TABLE E-14: NET INCREMENTAL (DIRECT + INDIRECT) MANUFACTURING COSTS FOR EVALUATED TRANSMISSION TECHNOLOGIES (6-SPEED AT, 8-SPEED AT, 6-SPEED DCT).....	90
TABLE E-16: APPLICATION OF INDIRECT COST MULTIPLIERS AND LEARNING CURVE FACTORS TO START-STOP HEV (BAS)	94

TABLE E-17: NET INCREMENTAL (DIRECT + INDIRECT) MANUFACTURING COST FOR EVALUATED START-STOP HEV (BAS)	94
TABLE E-19: POWER-SPLIT TECHNOLOGY CONFIGURATION INCREMENTAL DIRECT MANUFACTURING COSTS SYSTEM SUMMARY	101
TABLE E-20: POWER-SPLIT TECHNOLOGY CONFIGURATION, INCREMENTAL DIRECT MANUFACTURING COSTS, SYSTEM/SUBSYSTEM SUMMARY	102
TABLE E-21: APPLICATION OF INDIRECT COST MULTIPLIERS AND LEARNING CURVE FACTORS TO POWER-SPLIT HEVs	104
TABLE E-22: NET INCREMENTAL (DIRECT + INDIRECT) MANUFACTURING COST FOR EVALUATED POWER-SPLIT HEVs	105
TABLE E-24: P2 TECHNOLOGY CONFIGURATION, INCREMENTAL DIRECT MANUFACTURING COSTS, SYSTEM/SUBSYSTEM SUMMARY	111
TABLE E-25: APPLICATION OF INDIRECT COST MULTIPLIERS AND LEARNING CURVE FACTORS TO P2 HEVs	113
TABLE E-26: NET INCREMENTAL (DIRECT + INDIRECT) MANUFACTURING COST FOR EVALUATED P2 HEVs	114
TABLE E-27: APPLICATION OF INDIRECT COST MULTIPLIERS AND LEARNING CURVE FACTORS TO ELECTRICAL AIR CONDITIONING COMPRESSOR TECHNOLOGY	118
TABLE E-28: NET INCREMENTAL (DIRECT + INDIRECT) MANUFACTURING COST FOR EVALUATED ELECTRICAL AIR CONDITIONING COMPRESSORS	118
TABLE G-1: POWER-SPLIT VEHICLE SEGMENT ATTRIBUTE DATABASE FILE, PART 1 OF 3, BASE POWERTRAIN AND VEHICLE ATTRIBUTES	122
TABLE G-2: POWER-SPLIT VEHICLE SEGMENT ATTRIBUTE DATABASE FILE, PART 2 OF 3, ICE, ELECTRIC TRACTION MOTOR AND ELECTRIC GENERATOR SIZING	123
TABLE G-4: P2 VEHICLE SEGMENT ATTRIBUTE DATABASE FILE, PART 1 OF 3, BASE POWERTRAIN AND VEHICLE ATTRIBUTES	125
TABLE G-5: P2 VEHICLE SEGMENT ATTRIBUTE DATABASE FILE, PART 2 OF 3, ICE, ELECTRIC TRACTION MOTOR AND ELECTRIC GENERATOR SIZING	126
TABLE G-6: P2 VEHICLE SEGMENT ATTRIBUTE DATABASE FILE, PART 3 OF 3, HIGH VOLTAGE TRACTION MOTOR BATTERY SIZING	127

A. Executive Summary

The International Council on Clean Transportation (ICCT) contracted with FEV, Inc. to define the net incremental costs for a set of advanced light-duty vehicle technologies for the European vehicle market. The technologies selected are on the leading edge for reducing fuel consumption and emissions of greenhouse gases in the future, primarily in the form of tailpipe carbon dioxide (CO₂). This report addresses the transfer and conversion of information and results from existing advance vehicle powertrain cost analysis studies performed by FEV, based on U.S. market trends and manufacturing cost structures, into comparable European cost studies.

The original U.S. cost studies, performed for the United States Environmental Protection Agency (EPA), are based on a detailed, transparent, and robust teardown and costing methodology. Incremental direct manufacturing costs are developed by comparing hardware differences among new technology configurations (i.e., the advance technology offering) and against baseline vehicle technology configurations (i.e., current technology becoming the standard in the industry) having similar overall driving performance. Using comparison bill of materials, technical experts from both product and manufacturing engineering identify hardware differences between the two technologies as part of the teardown process. Components that are recorded as different are then evaluated using cost models that utilize data from comprehensive costing databases for raw materials, labor rates, manufacturing overhead, and mark-up costs. Where appropriate, results are scaled to other vehicle sizes and to similar technologies. Also, sensitivity analyses of key inputs such as raw material costs are performed. Marketplace validation is conducted at all stages of the analysis by cross-checking with data developed by entities and processes external to the team.

Since the costing methodology evaluates competing technologies (i.e., new technology configuration compared to a baseline technology configuration) under the same set of boundary conditions (e.g. high production volumes, equivalent market maturity, same manufacturing cost structure) an improved assessment of technology costs can be made. Reverse learning factors can then be applied to account for differences in boundary conditions (e.g. production volumes, marketplace competition, engineering, design, and testing allowances). For some technologies the application a forward learning factor is also possible based on projected increases in product and manufacturing maturity.

The alternative means of comparing the costs of advance technologies, relative to a baseline configuration, is founded on current production costs. Forward-learning factors are required to adjust the new technology configuration costs to an equal position on the learning curve such that a relatively equivalent comparison can be made. Unfortunately, this process is somewhat more speculative and as such is more susceptible to error.

The costing methodology developed by FEV and their partners provide a reasonable estimate of incremental direct manufacturing cost for competing technologies within a set

of predefined assumptions and boundary conditions. The processes and tools used are similar to those used by OEs and suppliers in the automotive industry. Further, FEV has successfully completed commercial customer projects that employ these same tools and processes. The customer base has included automotive and non-automotive transportation and energy customers, and these tools have been used to calculate both absolute and incremental component costs.

New cost models in this report, based off existing EPA models, are created in order to account for key differences between North American and European manufacturing cost parameters, vehicle segment characteristics, and technology configurations. In the EPA North American analysis, manufacturing processes and rates are based on data acquired from the United States. For the ICCT analysis, Germany's primary manufacturing methods and manufacturing cost structure/rates are used to support the European analysis. Since the cost models are based on manufacturing in advanced industrialized countries (i.e., U.S. and Germany), the calculated manufacturing costs tend to be on the conservative side. This is especially true for "add-on" technology configurations in which many of the components added to create the new technology configuration are in addition to the existing baseline components. In **Section F** a sensitivity analysis is performed on three engine studies to assess the impact on manufacturing costs if the parts are manufactured in Eastern Europe (i.e., using Eastern Europe labor rates).

Tables A-1 through **A-6** provide a summary of the calculated incremental costs for each of the technologies and vehicle segments evaluated for the European market analysis. The number of vehicle segments evaluated varied for each technology configuration base on customer requirements.

The tables present both incremental direct manufacturing costs and net incremental costs (direct manufacturing and indirect costs). The incremental direct manufacturing costs are calculated based on 2010/2011 economics, high production volumes (450K units/year), and mature market conditions. A complete detailed list of the boundary conditions established for the analysis is provided in **Section B** of the report.

The net incremental costs shown for production years 2012, 2016, 2020, and 2025 include factors to account for indirect manufacturing cost contributions and learning adjustments. An overview of the application of indirect cost multipliers (ICMs) and learning factors to the direct manufacturing are also included in the report. The ICM and Learning factors, along with application support, was provided by EPA to support the ICCT analysis.

Funding for this work was generously provided by Stiftung Mercator and the Climate Works Foundation.

Table A-1: Advanced Internal Combustion Engine Technology Configurations Evaluated

Technology	ID	Case Study #	Baseline Technology Configuration	New Technology Configuration	European Market Segment	European Vehicle Segment Example	Calculated Incremental <i>Direct</i> Manufacturing Cost 2010/2011 Production Year	Net Incremental Manufacturing Costs (<i>Direct + Indirect Costs</i>) with Applicable Learning Applied			
								2012	2016	2020	2025
Downsized, Turbocharged, Gasoline Direct Injection Internal Combustion Engines											
Engine	1	0100	1.4L, I4, 4V, DOHC, NA, PFI, dVVT, ICE	1.0L, I3, 4V, DOHC, Turbo, GDI, dVVT, ICE	Subcompact	VW Polo	€ 230	€ 423	€ 379	€ 305	€ 276
	2	0101	1.6L, I4, 4V, DOHC, NA, PFI, dVVT, ICE	1.2L, I4, 4V, DOHC, Turbo, GDI, dVVT, ICE	Compact/ Small	VW Golf	€ 360	€ 511	€ 466	€ 402	€ 372
	3	0102	2.4L, I4, 4V, DOHC, NA, PFI, dVVT, ICE	1.6L, I4, 4V, DOHC, Turbo, GDI, dVVT, ICE	Midsize	VW Passat	€ 367	€ 532	€ 484	€ 415	€ 383
	4	0103	3.0L, V6, 4V, DOHC, NA, PFI, dVVT, ICE	2.0L, I4, 4V, DOHC, Turbo, GDI, dVVT, ICE	Midsize/Large	VW Sharan	€ 80	€ 379	€ 328	€ 223	€ 189
	5	0106	5.4L, V8, 3V, SOHC, NA, PFI, sVVT, ICE	3.5L V6, 4V, DOHC, Turbo, GDI, dVVT, ICE	Large SUV	VW Touareg	€ 648	€ 992	€ 900	€ 760	€ 698
Variable Valve Timing and Lift, Fiat MultiAir System											
	6	0200	1.4L, I4, 4V, DOHC, NA, PFI, dVVT, ICE	1.4L, I4, 4V-MultiAir, SOHC, NA, PFI, ICE	Subcompact	VW Polo	€ 107	€ 159	€ 145	€ 126	€ 117

Table A-2: Advance Transmission Technology Configurations Evaluated

Technology	ID	Case Study #	Baseline Technology Configuration	New Technology Configuration	European Market Segment	European Vehicle Segment Example	Calculated Incremental <i>Direct</i> Manufacturing Cost 2010/2011 Production Year	Net Incremental Manufacturing Costs (<i>Direct + Indirect Costs</i>) with Applicable Learning Applied			
								2012	2016	2020	2025
Transmissions	1	0802	5-Speed AT	6-Speed AT	Midsize/Large	VW Sharan	(€ 79)	(€ 60)	(€ 60)	(€ 63)	(€ 63)
	2	0803	6-Speed AT	8-Speed AT	Large SUV	VW Touareg	€ 43	€ 59	€ 54	€ 47	€ 44
	3	0902	6-Speed AT	6-Speed Wet DCT	Midsize/Large	VW Sharan	(€ 121)	(€ 74)	(€ 74)	(€ 86)	(€ 86)

Table A-3: Advance Start-Stop Hybrid Electric Vehicle Technology Configuration Evaluated (Belt Alternator Generator Architecture)

Technology	ID	Case Study #	Baseline Technology Configuration	New Technology Configuration	European Market Segment	European Vehicle Segment Example	Calculated Incremental <u>Direct</u> Manufacturing Cost 2010/2011 Production Year	Net Incremental Manufacturing Costs (<u>Direct + Indirect Costs</u>) with Applicable Learning Applied			
								2012	2016	2020	2025
Start-Stop HEV	1	0402	Conventional Powertrain >I4 Gasoline ICE, 4V, DOHC, NA, PFI, VVT >4-Speed AT	Belt Alternator Starter (BAS) - HEV (Brake Regen & Launch Assist) >I4 Gasoline ICE, 4V, DOHC, NA, PFI, VVT >4-Speed AT >Electric Generator/Starter 14.5kW >Battery: 36V, 18.4Ah NiMH	Midsize	VW Passat	€ 1,176	€ 2,323	€ 1,632	€ 1,378	€ 1,226

Table A-4: Power-Split Hybrid Electric Vehicle Technology Configuration

Technology	ID	Case Study #	Baseline Technology Configuration	New Technology Configuration	European Market Segment	European Vehicle Segment Example	Calculated Incremental <i>Direct</i> Manufacturing Cost 2010/2011 Production Year	Net Incremental Manufacturing Costs (<i>Direct + Indirect Costs</i>) with Applicable Learning Applied			
								2012	2016	2020	2025
Power-Split HEV	1	0500	Subcompact car typically powered by an inline 4 cylinder engine, naturally aspirated, port fuel injection, 5-speed manual transmission (MT).	Power-split HEV System Power: 74.7kW ICE Power: 61.1kW (I4 -> I3) Traction Motor: 50kW Generator: 35.1kW Li-Ion Battery: 140V, 0.743kWh	Subcompact	VW Polo	€ 1,809	€ 4,555	€ 3,506	€ 2,624	€ 2,158
	2	0501	Compact or small car typically powered by an inline 4 cylinder engine, naturally aspirated, port fuel injection, 6-speed manual transmission or 7-speed dual clutch transmission (DCT).	Power-split HEV System Power: 90kW ICE Power: 73.6kW (I4 - DS I4) Traction Motor: 60.2kW Generator: 42.3kW Li-Ion Battery: 162V, 0.857kWh	Compact/ Small	VW Golf	€ 2,012	€ 5,034	€ 3,883	€ 2,908	€ 2,397
	3	0502	A midsize passenger car typically powered by a 4 cylinder turbocharged, direct fuel injection, 6-speed MT and AT or 7-speed DCT, Start/Stop system.	Power-split HEV System Power: 117kW ICE Power: 95.6kW (I4 -> DS I4) Traction Motor: 78.3kW Generator: 55kW Li-Ion Battery: 188V, 0.994kWh	Midsize	VW Passat	€ 2,230	€ 5,632	€ 4,331	€ 3,240	€ 2,663
	4	0503	A midsize or large passenger car typically powered by 4 and 6 cylinder turbocharged, direct fuel injection, 6-speed MT or ≥ 6 speed AT.	Power-split HEV System Power: 174.8kW ICE Power: 142.8kW (V6 -> I4) Traction Motor: 116.9kW Generator: 82.1kW Li-Ion Battery: 211V, 1.118kWh	Midsize/Large	VW Sharan	€ 2,215	€ 5,802	€ 4,410	€ 3,282	€ 2,671
	5	0505	A small or mid-sized sports-utility or cross-over vehicle, or a small-midsize SUV, or a Mini Van powered by a 4 cylinder turbocharged engine, direct fuel injection, 6-speed MT or AT & 7 DCT.	Power-split HEV System Power: 132.6kW ICE Power: 108.3kW (I4 -> DS I4) Traction Motor: 88.7kW Generator: 62.2kW Li-Ion Battery: 199V, 1.053 kWh	Small/Midsize SUV/COV	VW Tiguan	€ 2,336	€ 5,891	€ 4,532	€ 3,391	€ 2,788
	6	0506	Large sports-utility vehicles, typically powered by a 8 cylinder naturally aspirated engine, direct fuel injection, ≥ 6-speed AT.	n/a	Large SUV	VW Touareg	---	---	---	---	---

Table A-5: P2 Hybrid Electric Vehicle Technology Configuration

Technology	ID	Case Study #	Baseline Technology Configuration	New Technology Configuration	European Market Segment	European Vehicle Segment Example	Calculated Incremental <u>Direct</u> Manufacturing Cost 2010/2011 Production Year	Net Incremental Manufacturing Costs (<u>Direct + Indirect Costs</u>) with Applicable Learning Applied			
								2012	2016	2020	2025
P2 HEV	1	0700	Subcompact car typically powered by an inline 4 cylinder engine, naturally aspirated, port fuel injection, 5-speed manual transmission (MT).	P2 HEV System Power: 74.7kW ICE Power: 59.8kW (I4 -> I3) Traction Motor: 14.9kW Li-Ion Battery: 140V, 0.743kWh	Subcompact	VW Polo	€ 1,704	€ 4,391	€ 3,355	€ 2,502	€ 2,045
	2	0701	Compact or small car typically powered by an inline 4 cylinder engine, naturally aspirated, port fuel injection, 6-speed manual transmission or 7-speed dual clutch transmission (DCT).	P2 HEV System Power: 90kW ICE Power: 72kW (I4 -> DS I4) Traction Motor: 18kW Li-Ion Battery: 162V, 0.857kWh	Compact/ Small	VW Golf	€ 1,915	€ 4,914	€ 3,760	€ 2,806	€ 2,297
	3	0702	A midsize passenger car typically powered by a 4 cylinder turbocharged, direct fuel injection, 6-speed MT and AT or 7-speed DCT, Start/Stop system.	P2 HEV System Power: 117kW ICE Power: 93.6kW (I4 -> DS I4) Traction Motor: 23.4kW Li-Ion Battery: 188V, 0.994kWh	Midsize	VW Passat	€ 2,080	€ 5,398	€ 4,115	€ 3,067	€ 2,502
	4	0703	A midsize or large passenger car typically powered by 4 and 6 cylinder turbocharged, direct fuel injection, 6-speed MT or ≥ 6 speed AT.	P2 HEV System Power: 174.8kW ICE Power: 139.9kW (V6 -> I4) Traction Motor: 35.0W Li-Ion Battery: 211V, 1.118 kWh	Midsize/Large	VW Sharan	€ 1,947	€ 5,382	€ 4,023	€ 2,972	€ 2,382
	5	0705	A small or mid-sized sports-utility or cross-over vehicle, or a small-midsize SUV, or a Mini Van powered by a 4 cylinder turbocharged engine, direct fuel injection, 6-speed MT or AT & 7 DCT.	P2 HEV System Power: 132.6kW ICE Power: 106.1kW (I4 -> DS I4) Traction Motor: 26.5kW Li-Ion Battery: 199V, 1.053kWh	Small/Midsize SUV/COV	VW Tiguan	€ 2,164	€ 5,621	€ 4,284	€ 3,192	€ 2,603
	6	0706	Large sports-utility vehicles, typically powered by a 8 cylinder naturally aspirated engine, direct fuel injection, ≥ 6-speed AT.	P2 HEV System Power: 271.8kW ICE Power: 271.8 kW (No Change to V8) Traction Motor: 54.3 kW Li-Ion Battery: 269V, 1.427kWh	Large SUV	VW Touareg	€ 2,756	€ 7,156	€ 5,454	€ 4,064	€ 3,316

Table A-6: Electrical Air Conditioning Compressor Technology Configuration

Technology	ID	Case Study #	Baseline Technology Configuration	New Technology Configuration	European Market Segment	European Vehicle Segment Example	Calculated Incremental <u>Direct</u> Manufacturing Cost 2010/2011 Production Year	Net Incremental Manufacturing Costs (<u>Direct + Indirect Costs</u>) with Applicable Learning Applied			
								2012	2016	2020	2025
Electrical Air Conditioning Compressor Subsystem	1	0600	Mechanical Air Conditioning Compressor Subsystem	Electrical Air Conditioning Compressor Subsystem	Subcompact	VW Polo	€ 102	€ 159	€ 146	€ 117	€ 109
	2	0601	Mechanical Air Conditioning Compressor Subsystem	Electrical Air Conditioning Compressor Subsystem	Compact/Small	VW Golf	€ 106	€ 166	€ 153	€ 123	€ 114
	3	0602	Mechanical Air Conditioning Compressor Subsystem	Electrical Air Conditioning Compressor Subsystem	Midsize	VW Passat	€ 111	€ 174	€ 161	€ 129	€ 120
	4	0603	Mechanical Air Conditioning Compressor Subsystem	Electrical Air Conditioning Compressor Subsystem	Midsize/Large	VW Sharan	€ 115	€ 180	€ 166	€ 133	€ 124
	5	0604	Mechanical Air Conditioning Compressor Subsystem	Electrical Air Conditioning Compressor Subsystem	Small/Midsize SUV/COV	VW Tiguan	€ 118	€ 184	€ 169	€ 136	€ 126
	6	0605	Mechanical Air Conditioning Compressor Subsystem	Electrical Air Conditioning Compressor Subsystem	Large SUV	VW Touareg	€ 135	€ 212	€ 195	€ 157	€ 146

B. Introduction

B.1 Project Overview

The International Council for Clean Transportation (ICCT) contracted with FEV, Inc. to determine the net incremental costs for a set of advanced light-duty vehicle technologies for the European vehicle market. The technologies selected are on the leading edge for reducing fuel consumption and emissions of greenhouse gases in the future, primarily in the form of tailpipe carbon dioxide (CO₂).

The foundation of the analysis is based on previously completed detail teardown and cost analysis work conducted for the U.S. Environmental Protection Agency (EPA) by FEV and its subcontractors in a North American context. Accounting for key differences in manufacturing parameters, vehicle segment characteristics, and technology configurations, new cost models, based off existing EPA models, are developed.

The process of converting and running the European cost models, based on the original EPA North American cost models, is summarized below and shown in **Figure B-1**.

1. Establish manufacturing boundary conditions for European market.
2. Define suitable light-duty vehicle categories for the European context.
3. Develop appropriate scaling factors for each of the technologies under consideration for translation to the European vehicle segments
4. Update costing databases (e.g., material cost, labor cost, manufacturing overhead costs) with European parameters.
5. Run cost models with updated databases and scaling factors for each of the defined technology configurations and vehicle segments to establish **incremental direct manufacturing costs**.
6. Apply EPA-developed Indirect Cost Multipliers (ICMs) to each direct incremental manufacturing cost to establish **net incremental costs**.
7. Apply EPA-developed learning factors to net increment costs to account for product maturity differences (e.g., sales volume, design maturity, manufacturing maturity, etc.) between cost analysis boundary conditions and projected market boundary conditions.

Addition information on the original EPA cost model development methodology, and the conversion to the European market will be covered in the sections which follow.

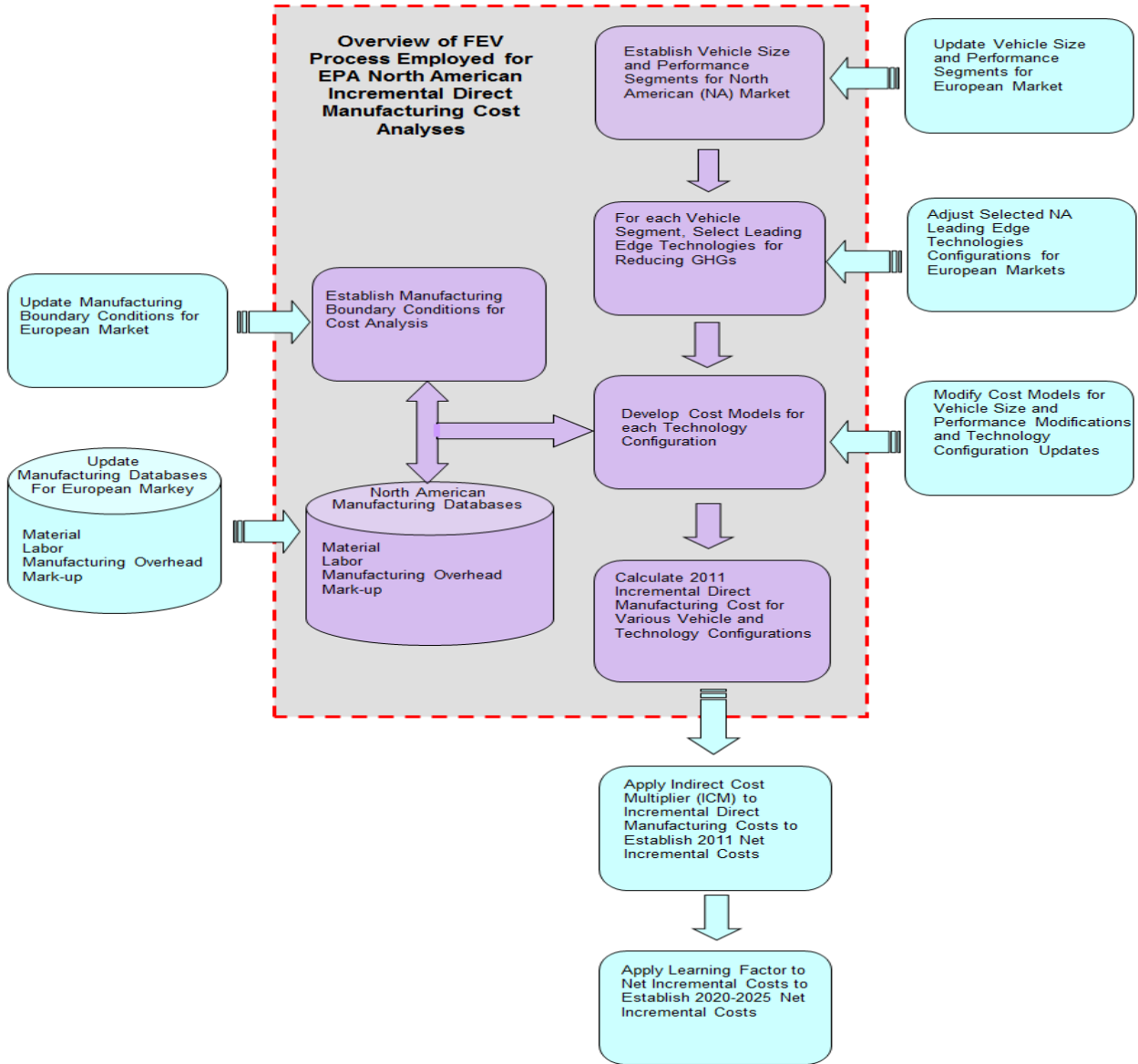

Figure B-1: Process Overview for Converting EPA North American Market Net Incremental Direct Manufacturing Costs to European Market Net Incremental Costs

B.2 Technologies Analyzed

B.2.1 Technologies Analyzed in the Phase 1 Analysis

The following list is the technology configurations evaluated. Each technology selected is evaluated against a baseline vehicle technology configuration representative of the current state of design with similar overall driving performance. Components that are unique to the new technology, as well as components modified to account for the new technology adaptation, are identified and analyzed to establish the incremental direct manufacturing costs.

1. Engine technology configurations
 - a. I4, Naturally Aspirated (NA), Port Fuel Injected (PFI) engine downsized to a smaller I4, Turbo, Gasoline Direct Inject (GDI) engine
 - b. V6, NA, PFI engine downsized to a I4, Turbo, GDI engine
 - c. V8, NA, PFI engine downsized to a V6, Turbo, GDI engine
2. Transmission technology configurations
 - a. 5-Speed Automatic Transmission (AT) in comparison to a 6-Speed AT
 - b. 6-Speed AT in comparison to an 8-Speed AT
 - c. 6-Speed AT in comparison to a 6-Speed Wet, Dual Clutch Transmission (DCT)
3. Hybrid Electric Vehicle (HEV) technology configurations
 - a. Belt Alternator Start (BAS) HEV in comparison to conventional powertrain vehicle
 - b. Power-Split HEV in comparison to a conventional powertrain vehicle
 - c. P2 HEV (i.e., single motor, twin clutch hybrid system) in comparison to a conventional powertrain vehicle

B.2.2 Technologies Considered for the Phase 2 Analysis

In addition to the new technology configurations covered in the Phase 1 analysis (listed above in Section B.2) a planned Phase 2 analysis will investigate the cost impact of the following technology configurations:

1. Advanced Down-Sized Diesel Engine Technologies
 - a. High-Pressure (2500 bar) Injection System in comparison to an 1800 Injection System
 - b. Variable Valve Timing and Lift Valvetrain System in comparison to a Conventional Valvetrain System
 - c. High-Pressure EGR in comparison to a High- and Low-Pressure EGR System
2. Advance Gasoline Engines

- a. EGR High-Load Application in a Turbocharged Gasoline Engine in comparison to a System without EGR
3. 6-Speed Dry Dual Clutch Transmission in comparison to a 6-Speed Manual Transmission
4. Start-Stop Hybrid System (with regenerative braking) in comparison to the same vehicle without the Start-Stop Technology
5. Conversion and transformation of the Toyota Venza Mass-Reduction and Cost analysis completed for the United States Environmental Protection Agency into cost models representative of the technology in the European market.

B.3 Process Overview

As previously discussed, the foundation of the cost analysis conducted by FEV for ICCT is based on previously completed detail teardown and cost analysis work. This previous work was conducted for the U.S. Environmental Protection Agency (EPA) by FEV and its subcontractors in a North American context.

In **Section B.3.1**, the costing methodology utilized in the EPA analyses to develop the net incremental direct manufacturing for a set of advance powertrain technologies is summarized in three sections: **Section B.3.1.1** provides a general overview of the costing methodology; **Section B.3.1.2** explains the major steps involved in the detailed teardown cost analysis process; and **Section B.3.1.3** explains the process used to scale the incremental direct manufacturing costs between different vehicle segments and/or technology configurations.

A comprehensive discussion of the costing methodology used to develop the incremental direct manufacturing cost can be found in the EPA published report “Light-Duty Technology Cost Analysis Pilot Study” (EPA-420-R-09-020). Details specific to the scaling methodology developed to scale the Ford Fusion power-split HEV analysis to alternative vehicle segments and to the P2 HEV configuration can be found in the published EPA report “Light-Duty Technology Cost Analysis, Power-Split and P2 HEV Case Studies” (EPA-420-R-11-015).

In **Section B.3.2**, the process of transferring and converting information and results for the North American/U.S. EPA case studies into comparable European cost studies is discussed.

B.3.1 EPA Project Costing Methodology

B.3.1.1 EPA Project Cost Methodology Overview

The costing methodology is based heavily on teardowns of both new and baseline technology configurations that have similar driving performance metrics. Only components identified as being different, within the selected new and baseline technology configurations, as a result of the new technology adaptation are evaluated for cost. Component costs are calculated using a ground-up costing methodology analogous to that employed in the automotive industry. All incremental costs for the new technology are calculated and presented using transparent cost models consisting of eight (8) core cost elements: material, labor, manufacturing overhead/burden, end item scrap, SG&A (selling general and administrative), profit, ED&T (engineering, design, and testing), and packaging.

For the EPA analysis, six (6) vehicle segments were considered relative to adding new advanced powertrain technology configurations. In several instances only one (1) vehicle segment was evaluated for a given technology configuration. This was especially true for technologies that would generally change only in size relative to accommodating alternative vehicle segments and the relative differences in power and torque requirements. Examples of technology configurations in which a single vehicle segment was evaluated for costs include: the 5- to 6-speed automatic transmission (AT) analysis, 6-speed AT to 6-speed dual clutch transmission (DCT) analysis, and the 6- to 8-speed AT analysis. For technology configurations that are significantly different (e.g., component types, component sizes, quantity of components, material selection) for different vehicle segments, several vehicle segments were evaluated. For example, for downsized, turbocharged, gasoline direct injection (GDI) engine technology configurations, three (3) vehicle segments were evaluated capturing the following three (3) downsized, turbocharged, GDI scenarios: I4 to smaller I4, V6 to I4, and V8 to V6.

For some technology configurations, due to the lack of available hardware in the marketplace and/or the associated costs and timing requirements for a detailed teardown and costing evaluation, a scaling methodology was employed to evaluate the incremental costs for a new technology configuration across multiple vehicle segments. In this case, a full cost analysis is completed for a technology configuration on an available vehicle segment. Using selected vehicle attributes (e.g., net vehicle horsepower, internal combustion engine horsepower, traction motor horsepower, traction motor battery size, wheel base, curb weight, interior volume) custom ratios are developed for scaling. This approach was applied to the EPA power-split technology configuration analysis. Results from the Ford Fusion power-split HEV teardown and cost analysis were scaled across three (3) other vehicle segments. A similar approach was taken for developing P2 HEV costs for all NA vehicle segments.

In the context of the EPA analysis, incremental **direct** manufacturing cost is the incremental difference in cost of components and assembly to the OEM, between the new technology and baseline technology configurations. The FEV calculated costs for the EPA analyses did not give consideration to any incremental OEM **indirect** costs. This portion of the analysis was carried out by EPA through the application of Indirect Cost Multipliers (ICMs). Reference EPA report EPA-420-R-09-003, February 2009, “Automobile Industry Retail Price Equivalent and Indirect Cost Multiplier,” for additional details on the development and application of ICM factors.

B.3.1.2 EPA Detailed Teardown Cost Analysis Process Overview

Listed below, with the aid of **Figure B-4** and **Figure B-5**, is a high-level summary of the thirteen (13) major steps taken during the EPA detailed teardown cost analysis process. For additional information concerning the terminology used within these steps, please reference the glossary of terms at the end of this report.

Step 1: Using the *Powertrain-Vehicle Class Summary Matrix (P-VCSM)*, a technology configuration and vehicle segment is selected for cost analysis.

Step 2: Existing vehicle models, representing the new technology configuration (i.e., the advance technology offering) and a baseline vehicle technology configuration (i.e., current technology becoming the standard in the industry), are identified for teardown to provide the basis for detailed incremental cost calculations.

Step 3: Pre-teardown *Comparison Bills of Materials (CBOMs)* are developed, covering hardware that exists in the new and base technology configurations. These high-level CBOMs are informed by the team’s understanding of the new and base technologies and serve to identify the major systems and components targeted for teardown.

Step 4: Phase 1 (high-level) teardown (**Figure B-2**) is conducted for all subsystems identified in Step 3 and the assemblies that comprise them. Using *Design Profit® software*, all high-level processes (e.g., assembly process of the high-pressure fuel pump onto the cylinder head assembly) are mapped during the disassembly.



Figure B-2: Sample of Components Removed During High Level Teardown of Fuel Induction System

Step 5: A *cross-functional team (CFT)* reviews all the data generated from the high-level teardown and identifies which components and assumptions should be carried forward into the cost analysis. The CBOMs are updated to reflect the CFT input.

Step 6: When conducting the cost analysis for each technology configuration, a number of assumptions and boundary conditions are required up front in the analysis prior to the start of any costing work. The same assumptions and boundary conditions are applied to both the new and baseline technology configurations, establishing a consistent framework for all costing, thereby resulting in a level playing field for comparison. These boundary conditions include items such as average annual production volumes, manufacturing locations, production year, and technology maturity.

Step 7: Phase 2 (component/assembly level) teardowns are initiated based on the updated CBOMs. Components and assemblies are disassembled and processes and operations are mapped in full detail. Photographs of the disassembly process and individual parts are captured in **Figure B-3**. The CBOMs are updated with the additional parts acquired from the further level of teardown. At this level of teardown component physical attributes are gathered, component materials established, and manufacturing process identified.



Figure B-3: Initial Level of Injector Teardown

Step 8: During the teardown process, process maps capturing every manufacturing operation are generated, including all key part input data and part specific manufacturing data. For simpler processes and/or serial type processes, process parameter models are set-up within the Design Profit® software to calculate part manufacturing data based on entered part data. For more complex and custom operations and processes, external process parameter models are developed.

In the custom process parameter models, which are developed using Microsoft Excel, part input parameters (e.g., material specifications, mass, volume, part geometry, part features, etc.) are fed into the models generating key output parameters (e.g., equipment type, equipment size, operation cycle times, material usage, etc.).

Subject matter experts develop and validate the process parameter models. Models are refined and validated by running surrogate parts through the analysis, which have existing industry data.

The key calculated manufacturing process data is then uploaded into the process maps. Once the process map is complete for a given assembly, the information can be loaded into the MAQS worksheets (**Step 9**) to develop the final manufacturing cost.

Step 9: Manufacturing Assumption and Quote Summary (MAQS) worksheets are generated for all parts undergoing the cost analysis. The MAQS details all cost elements

making up the final unit costs: material, labor, burden, end item scrap, SG&A, profit, ED&T, and packaging.

Step 10: Parts with high or unexpected cost results are subjected to a *marketplace cross-check*, such as comparison with supplier price quotes or wider consultation with company and industry resources (i.e., subject matter experts) beyond the CFT.

Step 11: All costs calculated in the MAQS worksheets are automatically inputted into the *Subsystem Cost Model Analysis Templates (CMAT)*. The Subsystem CMAT is used to display and roll up all the differential costs associated with a subsystem. For example, the crank-drive subsystem (reference **Figure B-6**) is comprised of several sub-subsystems (e.g., connecting rod sub-subsystem, piston sub-subsystem, crankshaft sub-subsystem). The sub-subsystems comprise of several components and assemblies. As shown in **Figure B-6**, the Connecting Rod sub-subsystem contains several components, including the rod-connecting, cap-rod connecting, bearing-rod connecting, and bolt-rod connecting. In the Subsystem CMAT Component/Assembly costs are grouped together in their respective sub-subsystems, which, in turn, are grouped together providing an incremental subsystem cost.

All parts in a subsystem that are identified for costing in the CBOM are entered into the Subsystem CMAT. Also, both the base and new technology configurations are included in the same CMAT to facilitate differential cost analysis.

Step 12: The *System CMAT* rolls up all the subsystem differential costs to establish a final system unit cost. The System CMAT, similar in function to the subsystem CMAT, is the document used to display and roll-up all the subsystem costs associated within a system as defined by the CBOM. In a System CMAT only the rolled-up subsystem costs are provided. For example, for the engine system (**Figure B-6**), the CMAT would capture the cost contribution of each major subsystem: crank-drive subsystem, cylinder block subsystem, cylinder head subsystem, valvetrain subsystem, etc. In many study cases, the cost analysis is based on comparing the cost differences for a single system (i.e., new engine technology configuration versus baseline engine). In these single system case studies, the system CMAT provides the incremental direct manufacturing impact.

Step 13: In case studies where multiple vehicle systems are evaluated, a vehicle level CMAT is required to capture the vehicle incremental direct manufacturing cost impact. In a vehicle CMAT, sub-totals for each vehicle system are presented along with a total vehicle incremental direct manufacturing cost. **Figure B-6** highlights some of the systems which are found in a vehicle analysis, such as Engine, Transmission, Body, and Suspension.

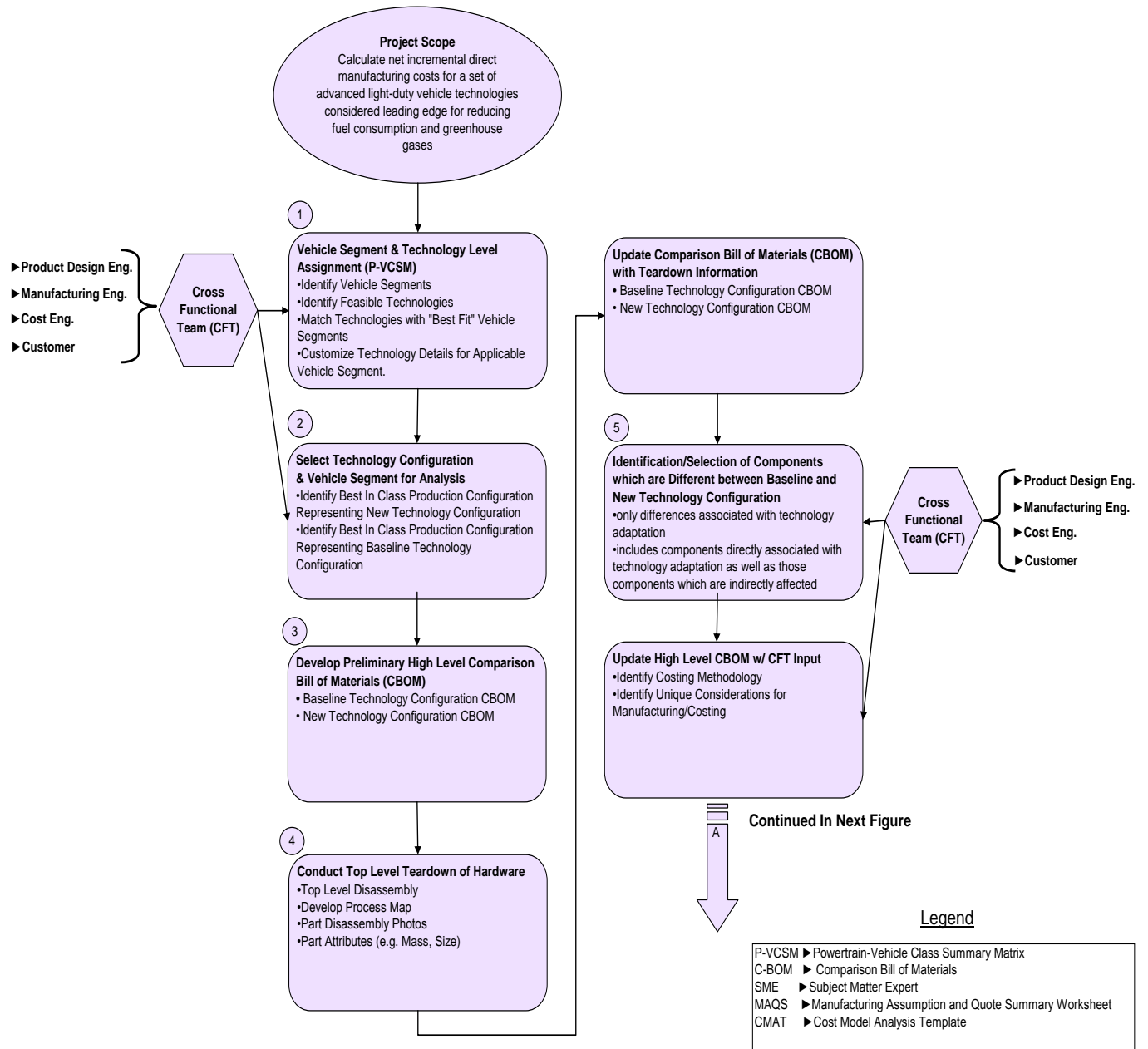

Figure B-4: Cost Analysis Process Flow Steps and Document Interaction (Part 1)

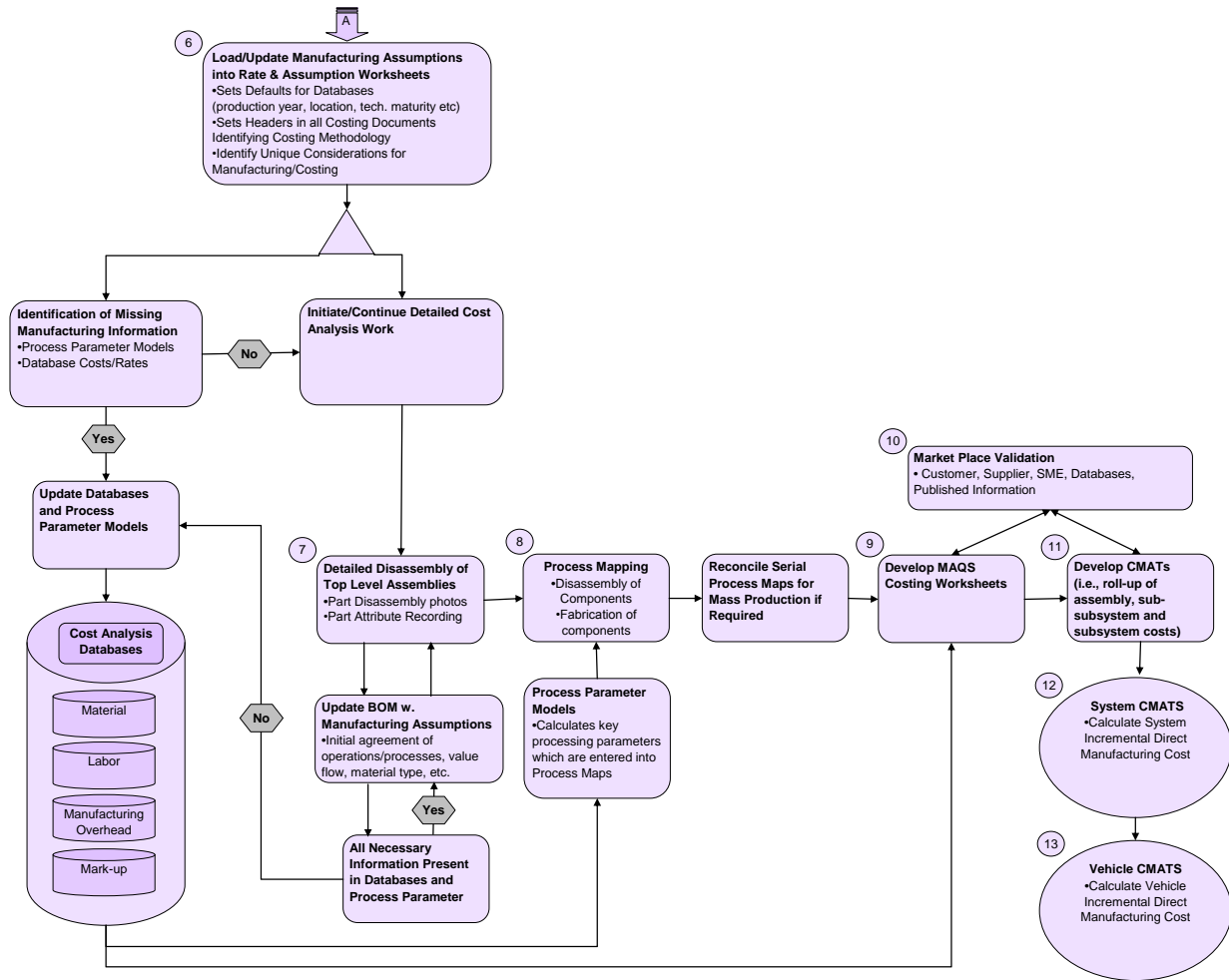

Figure B-5: Cost Analysis Process Flow Steps and Document Interaction (Part 2)

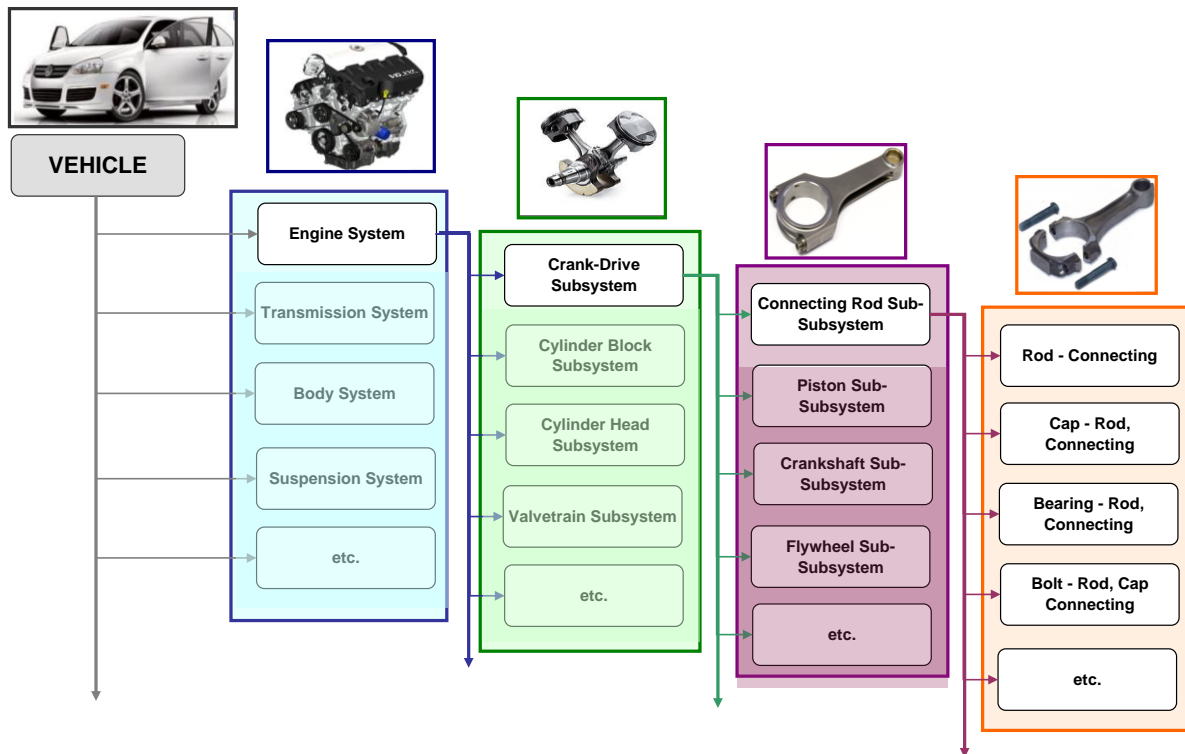

Figure B-6: Illustration of Bill of Material Structure used in Cost Analysis

B.3.1.3 EPA Scaling of Cost Analysis Data to Alternative Vehicle Segments

Listed below, with the aid of , is a high-level summary of the added steps required to scale the incremental direct manufacturing costs between different vehicle segments and/or technology configurations.

Step 1: Select previously complete incremental direct manufacturing cost case study (i.e., technology configuration and vehicle segment) for scaling analysis. In order to conduct a scaling analysis, a detailed cost analysis (as discussed in **Section B.3.1.2**) must first be completed.

Step 2: Identify alternative vehicle segments where the new technology configuration may also be adoptable. In some cases, alternative technologies may be a better fit for a certain vehicle segment.

Step 3: Identify key vehicle attributes (e.g., vehicle mass, internal combustion engine (ICE) configuration, ICE power, traction motor power, net powertrain system power, vehicle track width, wheelbase, etc.), which have direct or indirect impact on the selection of components used in the new technology configuration. For each vehicle segment included in the scaling analysis, the average value for each key attribute identified is calculated. Generally, the majority of this data is published by each

automotive OEM for their particular vehicle within the defined vehicle class. This provides a good sample size to calculate average vehicle attribute values. In some cases, where no data exists for a selected vehicle attribute in a selected vehicle segment, the EPA and FEV team will develop a scaling factor to scale the vehicle attribute to alternative vehicle segments.

Step 4: Once all key vehicle attribute data is collected, it is entered into a vehicle attribute database file. Within the database file some preliminary scaling parameter calculations are performed. The database file is then linked to the cost models so information can be automatically uploaded. All changes to vehicle attribute data is performed in the database file versus the cost models.

Step 5: Update CMATs at all levels (i.e., sub-subsystem, subsystem, system, and vehicle) to include alternative vehicle segments.

Step 6: In applicable CMATs, develop scaling parameters for each component, assembly, or sub-system. Scaling parameters are calculated using hard-coded formulas in the CMATs which download parameters from the vehicle attribute database file.

Multiple scaling methodologies were applied in the analysis based on the component type, the required change to the component for the new vehicle segment, and the data available. For example with the traction motor and generator, a ground-up cost calculation was developed for each assembly. Developing a cost/kW factor based on these two data points, costs were estimated for alternative size motors and generators.

In the scaling of the high voltage battery, several different scaling considerations were applied. For the various vehicle segments, the battery power capacity was increased/decreased by altering the number of sub-modules (one sub-module equals 8 D-cell NiMH batteries, which is approximately equal to 10.6V). In the Fusion Hybrid analysis there were 26 modules connected in series to provide 275V. To change the power capacity of the overall battery pack, sub-modules were added or deleted to suit the system requirements. As the number of sub-modules were added or subtracted from the analysis, so were the costs of the sub-modules. In addition to the sub-module costs, there were nine (9) other sub-subsystem categories that contributed to the overall high-voltage traction battery cost. For a few of these sub-subsystem categories (e.g., VO assembly, body wiring harness – low voltage), the change in material, manufacturing overhead, and labor were considered insignificant so no scaling from the Fusion Hybrid calculated costs was required. With some sub-subsystem (e.g., cooling, battery covers, and battery module assembly) the cost change was approximately proportional to the number of modules added or deleted. Thus, a cost scaling factor was developed based on number of modules for these types of sub-subsystems. In selected cases (e.g., Traction Battery Sensing and Control Modules), where much of the hardware in the sub-subsystem remained constant regardless the number of battery sub-modules added/deleted, only the hardware changes within the sub-subsystem were accounted for by one of two methods:

(1) adding or removing absolute component costs, or (2) applying a scaling factor against the components that would require change.

In the case of the high-voltage wire harnesses, a compensation factor was developed for each vehicle segment based on harness length change. Estimating other parameters of the harness would not significantly change (e.g., same connector count and performance specification, same battery current for all applications, same number of retention points), a cost per harness unit length change was applied for each vehicle segment. The same cost/unit length of harness used to develop the initial Fusion Hybrid model was used in the scaling portion of the analysis.

The scaling methodology for many low-value, low-complexity, general components, based on an increase or decrease in size from the detailed component analysis, utilized constant total manufacturing cost (TMC) and mark-up ratios to scale up or down. For example if the material content on a stamping doubled in size, estimations on the cycle time and overhead rates were made to account for the increase in labor and manufacturing overhead contributions. Once the TMC was calculated, a mark-up factor was applied to arrive at the final component cost of the new stamping. Typically, the mark-up factor was carriedover from the detailed component analysis.

Step 7: Once all CMAT sheets from the reference detailed cost analysis were updated to include the additional vehicle segments and scaling parameters for each component, assembly, or sub-subsystem, links to the vehicle attribute matrix were made to bring in the applicable vehicle segment data.

Step 8: In the final step, link updates are made between the system and subsystem CMATs, and vehicle and system level CMATs, to determine the net vehicle incremental direct manufacturing cost for each vehicle segment evaluated.

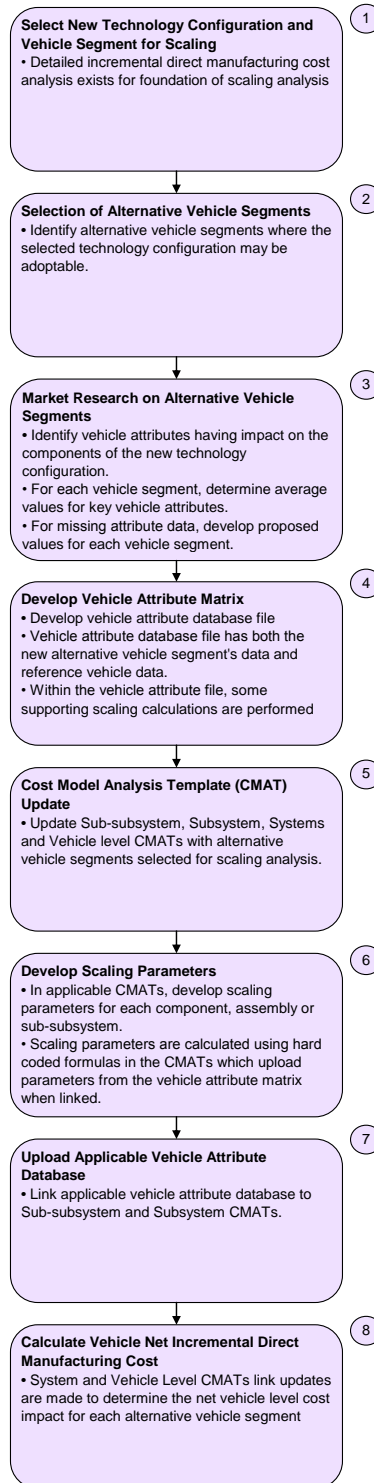

Figure B-7: Process Step Overview for Scaling Incremental Direct Manufacturing Costs to Alternative Vehicle Segments

In **Section B.4.1, Table B-2**, a summary of the technology configurations and vehicle segments analyzed for North America is provided. In addition, the types of cost models used for the analysis are also identified.

B.3.2 ICCT Project Costing Process Overview

As stated in the project overview section, the foundation of the European light-duty vehicle technology cost analysis is based on prior work completed for the United States Environmental Protection Agency (EPA). Using cost models developed in the EPA analysis, selected parameters were modified to transfer the North American/U.S. studies into comparable European studies. Three (3) main parameter categories were used in the U.S.-to-European cost model transformation process: cost model databases, primary vehicle segment attributes, and scaling factors for alternative vehicle segments. In

Figure B-8, the integration of these parameters is shown in the overall cost analysis methodology. The cost analysis process is explained in ten (10) steps:

Step 1: The EPA case study folders were pulled into a new ICCT project folder separating all links to existing databases. Two (2) sub-project folders were created: 2010/2011 North American Cost Models, and 2010/2011 European Cost Models.

Step 2: The EPA North American (NA) studies selected for the ICCT analysis were conducted over a three (3)-year time period spanning 2008-2011. To establish an NA reference baseline for costing, 2010/2011 NA databases were uploaded into the NA cost model folder.

Step 3: All EPA case studies previously completed in the 2008/2009 timeframe were re-run with the 2010/2011 NA databases, establishing updated incremental direct manufacturing costs.

Step 4: New European databases for each of the cost elements (e.g., material, labor, manufacturing overhead, and mark-up) were constructed. The cost databases fed cost models with costs and rates required to establish the incremental direct manufacturing costs. The European databases were uploaded into the 2010/2011 European cost models project folder. More discussion on how the cost model databases work is covered in **Section B.3.2.1**. The development of the each database (e.g., material, labor, and manufacturing overhead) is covered in **Section C**.

Step 5: For certain technology configurations evaluated (e.g., power-split HEV, P2 HEV), scaling models were developed to extrapolate the results from a detailed costs analysis, for a given technology configuration and a vehicle segment, to alternative vehicle segments. The foundation of the scaling analysis, as discussed in **Section B.3.1.3**, was based on selected vehicle attributes that drive component size and performance differences among the various vehicle segments. For the ICCT analysis, a new vehicle segment attribute database file was created for the European vehicle market.

Step 6: Each case study was linked to the European databases and specific vehicle attribute case study databases file where applicable. The cost models were run producing the net incremental direct manufacturing cost (NIDMC) for each case study evaluated. Comparisons are made to the updated North American studies to ensure no anomalies exist.

Step 7: If the incremental direct manufacturing cost calculated for a particular technology configuration and powertrain size matches to a European vehicle segment, no action was required. In this case, skip to step 8.

If the powertrain size did not quite fit a particular European vehicle segment, and/or a single technology configuration was applicable across multiple vehicle segments but required some level of adjustment for sizing and performance differences, scaling parameters were developed to make the appropriate incremental direct manufacturing cost adjustments.

Step 8: Once the net incremental direct manufacturing costs (NIDMC) were established for each case study, indirect cost multipliers (ICMs) were applied against each value for model years 2012 through 2025. The ICMs developed by EPA (reference EPA report EPA-420-R-09-003, February 2009, "Automobile Industry Retail Price Equivalent and Indirect Cost Multiplier") account for OEM specific indirect costs such as tooling depreciation and amortization, ED&T(engineering, design and testing)/R&D (research and development), warranty, corporate overhead, transportation, and marketing. ICM values vary with technology complexity and applicable production year/maturity. More discussion on the ICM factor is covered in **Section B.6**.

Step 9: In addition to applying an ICM factor to the net incremental direct manufacturing cost (NIDMC) for each case study for each production year, a learning factor is also similarly applied. The learning curve factor adjusts the NIDMC based on age/maturity of technology in the marketplace. The learning curve factors are also provided by EPA. Additional details on the learning curve factors chosen for each case study technology and applicable production years are found in **Section B.7**.

Step 10: Finally, after multiplying the net incremental direct manufacturing cost for each case study by the ICM and learning curve factors, the net incremental costs (direct + indirect) for each case study were established for 2012, 2016, 2020, and 2025 production years.

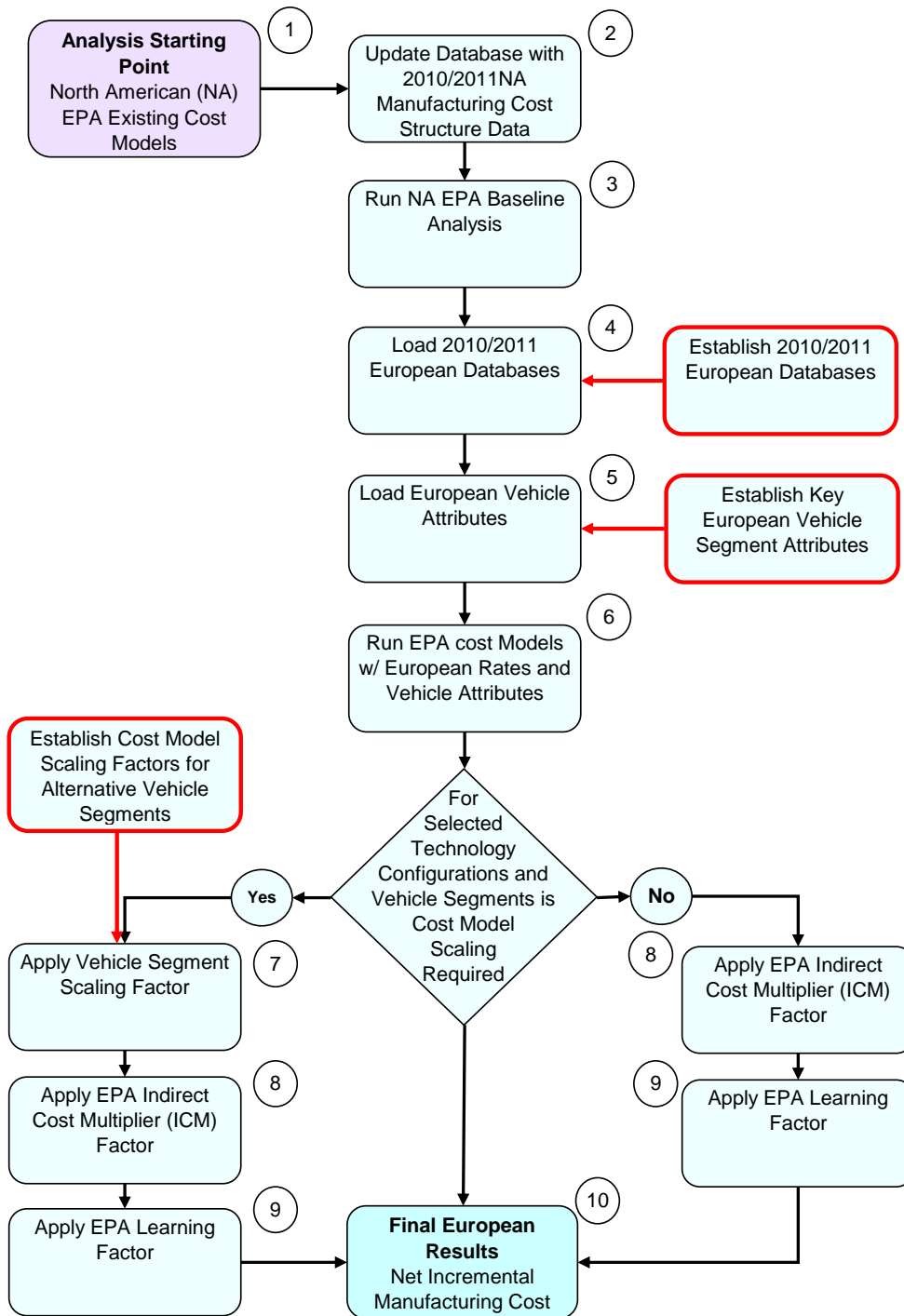

Figure B-8: ICCT Project Costing Methodology

As highlighted in the ICCT project costing methodology, three (3) main parameter categories were used in the U.S.-to-European cost model transformation process: cost model databases, primary vehicle segment attributes, and scaling factors for alternative vehicle segments. Additional details are discussed in the following two (2) sub-sections.

B.3.2.1 Cost Model Databases

FEV cost models are parameterized models that detail the cost make-up of a particular component and/or assembly. The models are transparent and flexible, thus making them powerful tools for understanding the cost drivers associated with the manufacturing of a particular part. The cost model template is also referred to as a manufacturing assumption-quote summary (MAQS) worksheet. The MAQS worksheet is used to assemble and organize key manufacturing process and cost data, and calculate the direct manufacturing cost. In many aspects the MAQS worksheet is similar to an automotive OEM quote worksheet, with the exception that much more of the supporting manufacturing and costing data is included in the MAQS worksheet.

There are two (2) main sources of data which feed the MAQS worksheets: the process parameter models and cost model databases. The process parameter models support the cost models with key manufacturing data required for the cost analysis. Process parameters models determine outputs such as raw material usage, type and size of processing equipment, quantity of machinery required, number of operators required, and process takt time.

The cost model databases support the cost models with the required financial data. For example, the material database contains all the materials referenced in the cost models along with the quoted material costs (e.g., cost/pound). The Labor Database provides loaded rates for the direct labor jobs references in the cost models. The Manufacturing Overhead (MOH) Database contains the hourly rates for the numerous pieces of equipment referenced in the cost models. In addition to the databases that support the Total Manufacturing Cost (TMC) (i.e., material, labor and manufacturing overhead), there are databases to address mark-ups and packaging costs. Important to note is all databases are linked to the MAQS worksheets. Thus, rate changes in any of the databases can quickly be evaluated in terms of the impact to the component or assembly cost.

For the ICCT analysis, the assumption was made that the manufacturing operations and processes employed to manufacture the various components and assemblies in the U.S. analysis would be similar to those used in industrialized European countries. For the ICCT analysis, Germany was considered the primary manufacturing location. Based on this assumption, the process parameters models and outputs into the European cost models remained the same as those used in the U.S. EPA analysis. Simply said, the method of fabricating and assembling powertrain components and assemblies in the U.S. would be very similar to the methods found in Germany. As such, no modifications were required to the process parameters models required.

Due to economic system differences between the U.S. and Europe, new costing databases were developed for each of the cost elements (e.g., material, labor, MOH) with the exception of the mark-up database. Since the process parameter models assumed Germany as the primary manufacturing location, the European database set was also developed based on 2010/2011 economic conditions in Germany.

The mark-up database assigns four (4) factors to the total manufacturing cost to cover Selling, General, and Administrative costs (SG&A), Profit, End-Item Scrap, and Engineering, Design and Testing (ED&T)/Research and Development (R&D) costs. As an example, if the SG&A for company “ABC” is 8%, and they are selling component “X,” which has a total manufacturing cost (TMC) of \$100.00, the mark-up contribution for SG&A would be \$8.00 ($\100×0.08). In the ICCT analysis the type of suppliers manufacturing automotive parts in Germany are considered to be similar to the U.S. infrastructure. Because of this, the mark-up factors are not modified between the U.S. and Europe analyses. More discussion on the databases can be found in **Section C**.

Figure B-9 is a simple illustration of a cost model for a plastic injection molding part to help explain the transformation of the U.S. EPA cost models into ICCT European cost models. As shown in the illustration, a common process parameter model supports either the NA EPA or Europe ICCT cost models. Process parameters such as raw material usage, number of operators, number of machines, number of parallel processes, and process takt time are assumed to remain the same regardless if manufacturing exists in the U.S. or Germany. The cost model databases, however, are unique for the U.S. and Europe cost models, as shown in the illustration. Rates, acquired for the country of manufacturing origin and in the local currency, are loaded into the cost model templates/MAQS worksheets along with the process parameters. Calculations are made in the cost models to arrive at material, labor, and manufacturing overhead cost contributions – the sum equaling total manufacturing cost (TMC). Adding the TMC to a calculated mark-up and packaging contribution, the direct manufacturing cost (DMC) is established. For the North American/U.S. Cost models, the DMC is calculated in U.S. dollars. In the Europe/Germany cost models, the DMC is calculated in Euros.

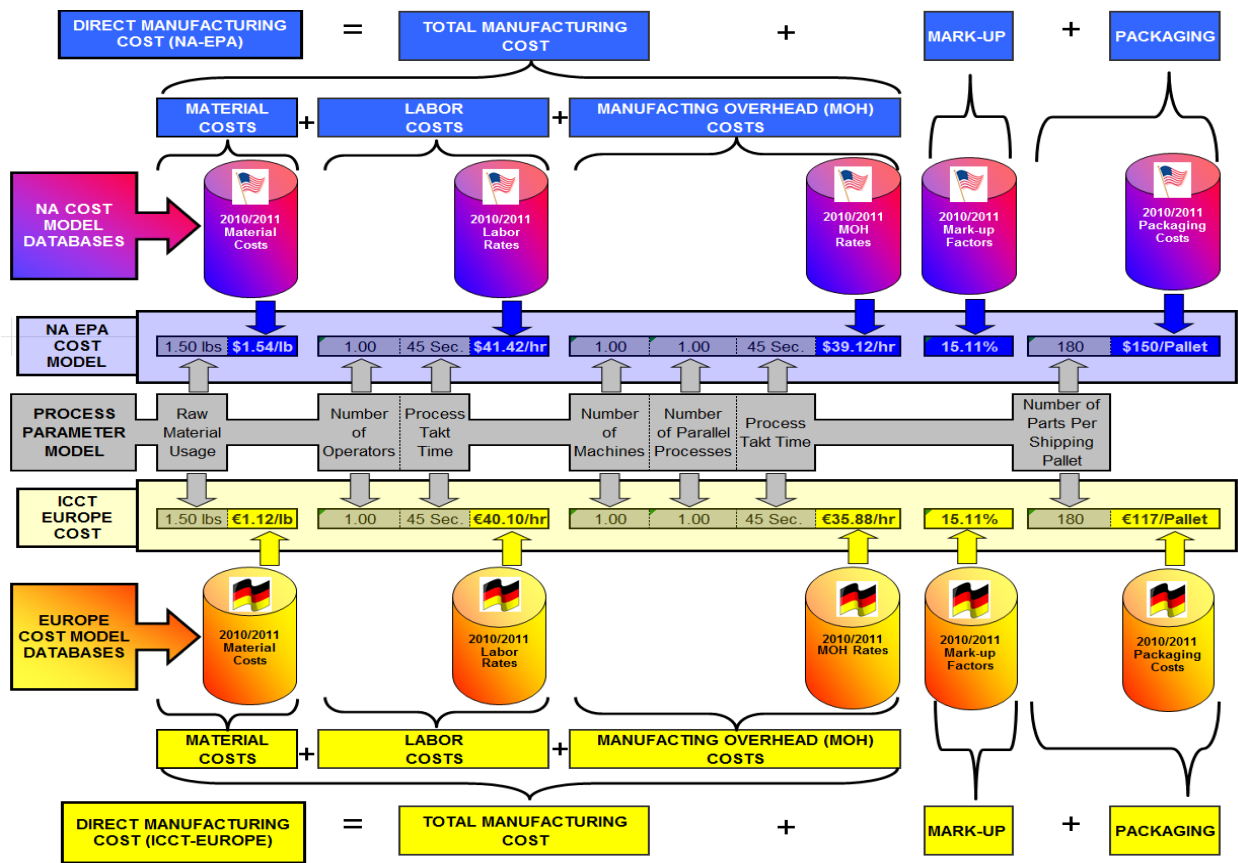

Figure B-9: Illustration Showing the Similarities and Differences between a US and Germany Cost Model for the Same Manufacturing Operation

B.3.2.2 Technology Configuration & Vehicle Segment Attribute Differences

Changing only the costing databases used in the various EPA case studies would result in European incremental direct manufacturing costs for technology configurations and vehicle segments based on the North American market. To ensure the incremental direct manufacturing costs were applicable to European market vehicles, market research was conducted to identify differences in technology configurations and vehicle segment attributes between the North American light-duty vehicle market and European vehicle market.

The same technology configurations evaluated in the EPA cost analysis studies were applicable to the European market in general, although the popularity of each technology as indicated by current and future projected market shares are notably different. For more traditional and mature technologies (e.g., internal combustion engines technologies, transmission technologies) this was especially true as the two markets have distinct divides on market acceptability for certain technologies (e.g., gasoline versus diesel

engines, automatic versus manual transmissions). For newer, non-mainstream technologies such as power-split and P2 HEV, the volumes were very low compared to conventional technologies. Therefore, no clear-cut market preference differences were found to exist between the North American and European markets (although available offerings of start-stop vehicle technology are significantly higher in Europe than in North America).

In addition to evaluating technology configuration differences between North America and Europe, vehicle segment differences were also investigated. The differences were accounted for in the cost analysis two different ways, based on the two types of cost models which were developed in the prior EPA work.

- I. The first type of cost models are custom models, providing a detailed net incremental cost for a single technology configuration and vehicle segment. These models are very rigid with limited flexibility for modifying vehicle segment attributes to determine the impact of a given technology configuration on alternative vehicle segments. Any assumption changes are accounted for by reworking the models and/or making adjustments externally to the model.
- II. The second type of cost models are designed to investigate the net incremental cost impact of a single technology configuration for multiple vehicle segments. These cost models are built-off the custom models discussed above, the process steps discussed in **Section 3.1.3**. The models have built-in flexibility for evaluating the incremental cost for a given technology configuration for different vehicle segments, by up-loading vehicle attribute data from a vehicle attribute file database file.

As previously mentioned, the EPA hybrid electrical vehicle (HEV) case studies (power-split and P2), used the second type of scaling models discussed above to translate the Ford Fusion HEV power-split detailed cost analysis results to: (1) alternative power-split vehicle segments, and (2) scale the results to a P2 HEV configuration, for various vehicle segments. This upfront model flexibility made it possible to customize the power-split and P2 analyses to match the European vehicle segments based on the powertrain and vehicle attribute data for each European vehicle segment. A summary of the vehicle attribute data used in the European power-split and P2 cost analyses can be found in **Section G.1** of the appendix.

For European analyses, which were based on custom EPA cost models, the ability to load European vehicles attribute was not possible. The approach taken to account for vehicle segment differences with these types of cost models was as follows:

- I. Try and match vehicle technology configurations and costs between North American and European vehicle segments. For example, a “compact or small vehicle” in the North American market has similar powertrain and vehicle attributes as a “midsize vehicle” in the European market. Therefore, the

downsizing, turbo, and gasoline direct injection cost models developed for the compact or small vehicle segment in NA could also be used for the midsize vehicle segment in Europe. **Table B-1** illustrates the technology configurations evaluated for the NA light-duty vehicle market and their applicability to European market segments. The case study numbers are those developed for the EPA analysis.

- II. For European vehicle segments and technology configurations requiring analysis, but not having a direct link to a NA vehicle segment and technology configuration, an alternative scaling methodology was employed. Vehicle segment scaling factors for a given technology configuration, were developed within the ICCT analysis and applied to the incremental direct manufacturing costs. **Table B-1** also illustrates the technology configurations developed for the NA light-duty vehicle market, directly applicable to selected European vehicle markets, and scaled to others European markets. Case study results and scaling parameters used in the analysis will be discussed in more detail in **Section E**.

Table B-1: Studied Technology Configurations Applicability to North American and European Vehicle Segments

Vehicle Powertrain Comparison			North American Vehicle Segments											
Vehicle Category Description			Subcompact car typically powered by an inline 4 cylinder engine, 5-Speed manual transmission (MT)		Compact or small car typically powered by an inline 4 cylinder engine, 4 & 5-Speed automatic transmission (AT)		A midsize or large passenger car typically powered by a V6 engine, 6-Speed automatic transmission (AT)		A minivan or large cross-over vehicle with large frontal area, typically powered by a V6, 6-speed AT, capable of carrying approx. 6 or more passengers.		A small or mid-sized sports-utility or cross-over vehicle, or a small-midsize pick-up truck, powered by a V6 or V8 engine, 5 & 6 Speed AT		Large sports-utility vehicles and large pick-up trucks, typically powered by a V8, 5 & 6-Speed AT	
Vehicle Category Example			Ford Fiesta		Ford Focus		Ford Fusion -> Ford Taurus		Ford Flex		Ford Ranger -> Escape -> Explorer		Ford Explorer -> F-150	
Typical Engine Size Range (Liters)			1.5-1.6		1.8-2.4		2.4-3.0		3.3-3.8		2.7-4.7		4.6-6.2	
Ave. Curb Weight (lb)			2,628	(2487)	3,118	(2846)	3,751	(3349)	4,087	(4045)	3,849	(4346)	4,646	(5120)
Ave. Power (hp)			128	(113)	155	(149)	267	(194)	233	(269)	210	(248)	263	(317)
Ave. Torque (lb'ft)			126	(108)	150	(143)	260	(182)	234	(250)	237	(251)	290	(349)
Weight-to-Power Ratio (lb/hp)			21	(22)	20	(19)	14	(17)	18	(15)	18	(18)	18	(16)
European Vehicle Segments	Subcompact car typically powered by an inline 4 cylinder engine, naturally aspirated, port fuel injection, 5-speed manual transmission (MT).	VW Polo, Ford Fiesta	1.2-1.4	100	108	24	1. EPA CS#0200 Fiat Multi-Air	1. ICCT CS#0100 DS (I4->I3) Turbo GDI	ICCT Case Study Results for #0100 and #0101 are based on scaled results from EPA Case Study #0101 & 0102					
	Compact or small car typically powered by an inline 4 cylinder engine, naturally aspirated, port fuel injection, 6-speed manual transmission or 7-speed dual clutch transmission (DCT).	VW Golf, Ford Focus	1.4-1.6	121	132	23		1. ICCT CS#0101 DS (I4->I4) Turbo GDI						
	A midsize passenger car typically powered by a 4 cylinder turbocharged, direct fuel injection, 6-speed MT and AT or 7-speed DCT, Start/Stop system.	VW Passat, Audi A4	1.6-2.0	157	174	21	1. EPA CS#0101 DS (I4->I4) Turbo GDI							
	A midsize or large passenger car typically powered by 4 and 6 cylinder turbocharged, direct fuel injection, 6-speed MT or ≥ 6 speed AT.	VW Skoda, BMW 5 Series, Audi A6	2.0-3.0	234	237	16			1. EPA CS#0102 DS (V6->I4) Turbo GDI					
									2. EPA CS#0802 5-Speed AT -> 6-Speed AT					
									3. EPA CS#0902 6-Speed AT -> 6-Speed DCT					
	Executive passenger cars powered typically by 8 cylinder engine, naturally aspirated, direct fuel injection, ≥ 6-speed AT.	VW Phaeton, BMW 7 Series, Audi A8	3.0-5.0	371	364	12	Segment Not Applicable							
A small or mid-sized sports-utility or cross-over vehicle, or a small-midsize SUV, or a Mini Van powered by a 4 cylinder turbocharged engine, direct fuel injection, 6-speed MT or AT & 7 DCT.	VW Tiguan, BMW X1/X3, Audi Q5	1.2-3.0	178	195	20	1. EPA CS#0101 DS (I4->I4) Turbo GDI								
Large sports-utility vehicles, typically powered by a 8 cylinder naturally aspirated engine, direct fuel injection, ≥ 6-speed AT.	VW Touareg, BMW X5/X6, Audi Q7	3.0-5.5	364	362	13								1. EPA CS#0104 DS (V8->V6) Turbo GDI 2. EPA CS#1005 6-Speed AT -> 8-Speed AT	

B.4 Market Segment Comparison & Technology Overview

B.4.1 North American Market Analysis Overview

Shown in the Powertrain – Vehicle Class Summary Matrix (**Table B-2**) are the cost analysis studies completed for the United States Environmental Protection Agency (EPA). There were twenty (20) total cost studies completed, of which eleven (11) were based on detailed hardware teardowns (i.e., custom cost models) and nine (9) based on modifying previous developed custom models for alternative vehicle segments and technology configurations. Case studies which were based on custom cost models are highlighted with blue shaded boxes. Green highlighted case studies indicate scalable cost models were utilized to address the cost impact of a selected technology configuration on alternative vehicle segments. Finally, the purple highlighted boxes represent case studies that were analyzed using scalable, modified models to assess the cost impact of a given technology configuration across several vehicle segments. In the context of this project, “scalable modified model” refers to the modification of a custom cost model, which was developed for one technology configuration and modified to represent an alternative technology configuration having similar component content (i.e., power-split HEV cost models modified to support P2 HEV costing). In addition, scalable modified models were developed so the cost impact could be assessed across several vehicle segments.

Across the top of **Table B-2** are the vehicle segments which were evaluated for the EPA analysis along with the key powertrain attribute data for each. The vehicle segment definitions and attribute data were furnished by the EPA for the analysis. Along the left side of the table is a high-level description of the new technology configurations evaluated along with the comparative baseline technology configuration. Every technology evaluated has a case study number comprising of four (4) digits. The first pair of digits is the technology identification digits. The second pair represents the vehicle segment identification digits. For example, case study #0102 represents the cost analysis work for downsizing a gasoline internal combustion by employing turbocharging and direct injection (Tech ID# - 01) for a mid- to large-size passenger vehicle (Vehicle ID# - 02).

In **Table B-3**, links can be found to five (5) published EPA reports, covering the details of twenty (20) case studies evaluated. For each technology configuration evaluated, case study numbers are listed along with the associated EPA report and Internet link.

Table B-2: EPA North American Powertrain Vehicle Class Summary Matrix (P-VCSM)

Powertrain - Vehicle Class Summary Matrix (P-VCSM)			North American Vehicle Segments						
			Veh. ID#	00	01	02	03	04	05
= Custom Models, Single Vehicle Segment = Scalable Models, Multiple Vehicle Segments = Scalable Models, Multiple Vehicle Segments and Technologies Modifications relative to Custom Model = Custom Models, Single Vehicle Segment Result Scaled to Alternative Vehicle Segments			Subcompact car typically powered by an inline 4 cylinder engine, 5-Speed manual transmission (MT)	Compact or small car typically powered by an inline 4 cylinder engine, 4 & 5-Speed automatic transmission (AT)	A midsize or large passenger car typically powered by a V6 engine, 6-Speed automatic transmission (AT)	A minivan or large cross-over vehicle with large frontal area, typically powered by a V6, 6-speed AT, capable of carrying approx. 6 or more passengers.	A small or mid-sized sports-utility or cross-over vehicle, or a small-midsize pick-up truck, powered by a V6 or V8 engine, 5 & 6-Speed AT	Large sports-utility vehicles and large pick-up trucks, typically powered by a V8, 5 & 6-Speed AT	
Vehicle Category Example			Ford Fiesta	Ford Focus	Ford Fusion - Ford Taurus	Ford Flex	Ford Ranger-Escape-Explorer	Ford Explorer -> F-150	
Typical Engine Size Range (Liters)			1.5-1.6	1.8-2.4	2.4-3.0	3.3-3.8	2.7-4.7	4.6-6.2	
Ave. Curb Weight (lb) ₍₁₎			2,628	3,118	3,751	4,087	3,849	4,646	
Ave. Power (hp) ₍₁₎			128	155	267	233	210	263	
Ave. Torque (lb*ft) ₍₁₎			126	150	260	234	237	290	
Weight-to-Power Ratio (lb/hp)			21	20	14	18	18	18	
Tech. ID#	Technology Level	Technology Description							
01	New Technology Configuration	Downsized, turbocharged, gasoline direct injection (GDI), dual variable valve timing (dVVT), internal combustion engine (ICE)		1.6L, I4, 4V, DOHC, Turbo, GDI, dVVT, ICE	2.0L, I4, 4V, DOHC, Turbo, GDI, dVVT, ICE			3.5L V6, 4V, DOHC, Turbo, GDI, dVVT, ICE	
	Base Technology Configuration	Port-fuel injected, 4-valve, naturally aspirated gasoline engine, dual variable valve timing		2.4L, I4, 4V, DOHC, NA, PFI, dVVT, ICE	3.0L, V6, 4V, DOHC, NA, PFI, dVVT, ICE			5.4L, V8, 3V, SOHC, NA, PFI, sVVT, ICE	
02	New Technology Configuration	Variable Valve Lift and Timing (Multi-Air), Naturally Aspirated, Port Fuel Injection Engine	1.4L, I4, 4V-MultiAir, SOHC, NA, PFI, ICE						
	Base Technology Configuration	Port-fuel injected, 4-valve, naturally aspirated gasoline engine, dual variable valve timing	1.4L, I4, 4V, DOHC, NA, PFI, dVVT, ICE						
04	New Technology Configuration	Mild hybrid vehicle, start-stop technology with launch assist and regenerative braking.			2007 Saturn Vue Greenline Start-Stop BAS Technology				
	Base Technology Configuration	Conventional powertrain vehicle (ICE and Transmission) with similar power and torque performance attributes.			2007 Saturn Vue Conventional Powertrain				
05	New Technology Configuration	Power-split hybrid electric vehicle	2010 Ford Fusion Power-Split Cost Models Updated for Subcompact Vehicle Segment HEV Parameters	2010 Ford Fusion Power-Split Cost Models Updated for Compact/Small Vehicle Segment HEV Parameters	2010 Ford Fusion Power-split HEV, I4 ICE w/ eCVT	2010 Ford Fusion Conventional Powertrain	2010 Ford Fusion Power-Split Cost Models Updated for Minivan/COV Vehicle Segment HEV Parameters		
	Base Technology Configuration	Conventional powertrain vehicle (ICE and Transmission) with similar power and torque performance attributes.							
06	New Technology Configuration	Electrically driven air conditioning compressor unit			2010 Ford Fusion Elect. Powered AC Compressor				
	Base Technology Configuration	Mechanically driven air conditioning compressor unit			2010 Ford Fusion Mech. Powered AC Compressor				
07	New Technology Configuration	P2 hybrid electric vehicle	2010 Ford Fusion Power-Split Cost Models Converted to P2 HEV Subcompact Configuration	2010 Ford Fusion Power-Split Cost Models Converted to P2 HEV Compact/Small Configuration	2010 Ford Fusion Power-Split Cost Models Converted to P2 HEV Midsize/Large Configuration	2010 Ford Fusion Power-Split Cost Models Converted to P2 HEV Minivan/COV Configuration	2010 Ford Fusion Power-Split Cost Models Converted to P2 HEV Small/Midsize Truck Configuration	2010 Ford Fusion Power-Split Cost Models Converted to P2 HEV Large Truck Configuration	
	Base Technology Configuration	Conventional powertrain vehicle (ICE and Transmission) with similar power and torque performance attributes.							
08	New Technology Configuration	6-speed automatic transmission			2007 Toyota 6-Speed FWD AT (U660E)				
	Base Technology Configuration	5-speed automatic transmission			2005 Toyota 6-Speed FWD AT (U151E)				
09	New Technology Configuration	6-speed wet dual clutch transmission			2009 VW 6-Speed FWD Wet DCT (DQ250)				
	Base Technology Configuration	6-speed automatic transmission			2007 Toyota 6-Speed AT FWD (U660E)				
10	New Technology Configuration	8-speed automatic transmission						2010 ZF 8-Speed RWD AT (8HP70)	
	Base Technology Configuration	6-speed automatic transmission						2009 ZF 6-Speed RWD AT (6HP28)	
12	New Technology Configuration	8-speed wet dual clutch transmission			8-Speed FWD Wet DCT concept based on DQ250				
	Base Technology Configuration	6-speed wet dual clutch transmission			2009 VW 6-Speed FWD Wet DCT (DQ250)				

NOTES: (1) EPA, 2008 sales weighted powertrain attribute data per defined vehicle class.

Table B-3: EPA Published Reports for Evaluated Technology Configurations

Tech. ID#	Technology Level	Technology Description	Case Studies	Report Titles	Report Links
01	New Technology Configuration	Downsized, turbocharged, gasoline direct injection (GDI), dual variable valve timing (dVVT, internal combustion engine (ICE)	A. #0101 B. #0102 & #0105 ⁽¹⁾	A. Light-Duty Technology Cost Analysis Pilot Study B. Light-Duty Technology Cost Analysis, Report on Additional Case Studies	A. http://www.epa.gov/otaq/climate/420r09020.pdf B. http://www.epa.gov/otaq/climate/420r10010.pdf
	Base Technology Configuration	Port-fuel injected, 4-valve, naturally aspirated gasoline engine, dual variable valve timing			
02	New Technology Configuration	Variable Valve Lift and Timing (Multi-Air), Naturally Aspirated, Port Fuel Injection Engine	A. #0200	A. Light-Duty Vehicle Technology Cost Analysis, Mild Hybrid and Valvetrain Technology	A. http://www.epa.gov/otaq/climate/documents/420r11023.pdf
	Base Technology Configuration	Port-fuel injected, 4-valve, naturally aspirated gasoline engine, dual variable valve timing			
04	New Technology Configuration	Mild hybrid vehicle, start-stop technology with launch assist and regenerative braking.	A. #0402	A. Light-Duty Vehicle Technology Cost Analysis, Mild Hybrid and Valvetrain Technology	A. http://www.epa.gov/otaq/climate/documents/420r11023.pdf
	Base Technology Configuration	Conventional powertrain vehicle (ICE and Transmission) with similar power and torque performance attributes.			
05	New Technology Configuration	Power-split hybrid electric vehicle	A. #0500 #0501 #0502 #0503	A. Light-Duty Technology Cost Analysis, Power-Split and P2 HEV Case Studies	A. http://www.epa.gov/otaq/climate/documents/420r11015.pdf
	Base Technology Configuration	Conventional powertrain vehicle (ICE and Transmission) with similar power and torque performance attributes.			
06	New Technology Configuration	Electrically driven air conditioning compressor unit	A. #0602 ⁽²⁾	A. Light-Duty Technology Cost Analysis, Power-Split and P2 HEV Case Studies	A. http://www.epa.gov/otaq/climate/documents/420r11015.pdf
	Base Technology Configuration	Mechanically driven air conditioning compressor unit			
07	New Technology Configuration	P2 hybrid electric vehicle	A. #0700 #0701 #0702 #0703 #0704 #0705	A. Light-Duty Technology Cost Analysis, Power-Split and P2 HEV Case Studies	A. http://www.epa.gov/otaq/climate/documents/420r11015.pdf
	Base Technology Configuration	Conventional powertrain vehicle (ICE and Transmission) with similar power and torque performance attributes.			
08	New Technology Configuration	6-speed automatic transmission	A. #0802	A. Light-Duty Technology Cost Analysis, Report on Additional Case Studies	A. http://www.epa.gov/otaq/climate/420r10010.pdf
	Base Technology Configuration	5-speed automatic transmission			
09	New Technology Configuration	6-speed wet dual clutch transmission	A. #0902	A. Light-Duty Technology Cost Analysis, Report on Additional Case Studies	A. http://www.epa.gov/otaq/climate/420r10010.pdf
	Base Technology Configuration	6-speed automatic transmission			
10	New Technology Configuration	8-speed automatic transmission	A. #1005	A. Light-Duty Vehicle Technology Cost Analysis, Advanced 8-Speed Transmissions	A. http://www.epa.gov/otaq/climate/documents/420r11022.pdf
	Base Technology Configuration	6-speed automatic transmission			
12	New Technology Configuration	8-speed wet dual clutch transmission	A. #1202	A. Light-Duty Vehicle Technology Cost Analysis, Advanced 8-Speed Transmissions	A. http://www.epa.gov/otaq/climate/documents/420r11022.pdf
	Base Technology Configuration	6-speed wet dual clutch transmission			

Notes: (1) Case Study #1004 was changed to #1005 following a realignment of vehicle segment definitions
 (2) Electric AC Compressor versus Mechanical AC Compressor included as part of Ford Fusion Power-split HEV analysis.

B.4.2 European Market Analysis Overview

A similar Powertrain-vehicle summary matrix (P-VCSM) was completed for the European market analysis (**Table B-4**). The same technology configurations are captured along the left side of the table. Along the top of the table, vehicle segments are defined for the European market. Note the vehicle segment “Executive Passenger Cars” Vehicle ID #04 was excluded from the analysis and is not shown in the table. For each vehicle segment captured, primary powertrain attribute values are captured. The values are typically represented as averages, calculated using powertrain data from five (5) to seven (7) different European vehicles existing in the applicable vehicle segment. Vehicle data is based on 2010/2011 published OEM numbers.

Using the similar highlighting scheme as in the North American P-VCSM, the costing methodologies used for each case study are identified. In general, all blue highlighted cases studies are custom cost model analyses having a fit to a European market segment. For the power-split and air conditioning compressor case studies (highlighted in green), scalable North American cost models existed allowing for the convenient uploading of European vehicle segment attributes. Similarly, scalable modified models for the P2 technology configuration (highlighted in purple) were previously developed for the North American analysis, making it convenient to load in the European vehicle segment attributes. One additional scaling methodology, not included in the North America P-VCSM, is the scaling of final results for a given technology configuration to alternative vehicle segments. For these unique case studies (highlighted in red), final incremental costs at a subsystem level are scaled to alternative vehicle segments using ratios developed in the custom model analysis. Unlike “scaling cost models” where scaling occurs internal to the cost models, the scaling in these types of analyses occurs after the final incremental direct manufacturing costs are calculated. These types of scaling exercises generally have limitations, including lower resolution to cost elements and component, sub-subsystem and subsystem cost breakdowns. The scaling methodology for case studies 0100 and 0101 will be discussed in greater detail in **Section E**.

Table B-4: European Powertrain Vehicle Class Summary Matrix (P-VCSM)

Powertrain - Vehicle Class Summary Matrix (P-VCSM)		European Vehicle Segments						
		Veh. ID#	00	01	02	03	05	06
= Custom Models, Single Vehicle Segment = Scaleable Models, Multiple Vehicle Segments = Scaleable Models, Multiple Vehicle Segments and Technologies Modifications relative to Custom Model = Custom Models, Single Vehicle Segment Result Scaled to Alternative Vehicle Segments			Subcompact car typically powered by an inline 4 cylinder engine, naturally aspirated, port fuel injection, 5-speed manual transmission (MT).	Compact or small car typically powered by an inline 4 cylinder engine, naturally aspirated, port fuel injection, 6-speed manual transmission or 7-speed dual clutch transmission (DCT).	A midsize passenger car typically powered by a 4 cylinder turbocharged, direct fuel injection, 6-speed MT and AT or 7-speed DCT, Start/Stop system.	A midsize or large passenger car typically powered by 4 and 6 cylinder turbocharged, direct fuel injection, 6-speed MT or 6 speed AT.	A small or mid-sized sports-utility or cross-over vehicle, or a small-midsize SUV, or a Mini Van powered by a 4 cylinder turbocharged engine, direct fuel injection, 6-speed MT or AT & 7 DCT.	Large sports-utility vehicles, typically powered by a 8 cylinder naturally aspirated engine, direct fuel injection, 6-speed AT.
Vehicle Category Example			VW Polo, Ford Fiesta	VW Golf, Ford Focus	VW Passat, BMW 3 Series	VW Sharan, BMW 5 Series	VW Tiguan, BMW X1/X3	VW Touareg, BMW X5/X6
Typical Engine Size Range (Liters)			1.2-1.4	1.4-1.6	1.6-2.0	2.0-3.0	1.2-3.0	3.0-5.5
Ave. Curb Weight (lb) ₍₁₎			2,390	2,803	3,299	3,749	3,505	4,867
Ave. Power (hp) ₍₁₎			100	121	157	234	178	364
Ave. Torque (lb'ft) ₍₁₎			108	132	174	237	195	362
Weight-to-Power Ratio (lb/hp)			24	23	21	16	20	13
Tech. ID#	Technology Level	Technology Description						
01	New Technology Configuration	Downsized, turbocharged, gasoline direct injection (GDI), dual variable valve timing (dVVT), internal combustion engine (ICE)	1.0L, I3, 4V, DOHC, Turbo, GDI, dVVT, ICE	1.2L, I4, 4V, DOHC, Turbo, GDI, dVVT, ICE	1.6L, I4, 4V, DOHC, Turbo, GDI, dVVT, ICE	2.0L, I4, 4V, DOHC, Turbo, GDI, dVVT, ICE		3.5L V6, 4V, DOHC, Turbo, GDI, dVVT, ICE
	Base Technology Configuration	Port-fuel injected, 4-valve, naturally aspirated gasoline engine, dual variable valve timing	1.4L, I4, 4V, DOHC, NA, PFI, dVVT, ICE	1.6L, I4, 4V, DOHC, NA, PFI, dVVT, ICE	2.4L, I4, 4V, DOHC, NA, PFI, dVVT, ICE	3.0L V6, 4V, DOHC, NA, PFI, dVVT, ICE		5.4L V8, 3V, SOHC, NA, PFI, sVVT, ICE
02	New Technology Configuration	Variable Valve Lift and Timing (Multi-Air), Naturally Aspirated, Port Fuel Injection Engine	1.4L, I4, 4V, MultiAir, SOHC, NA, PFI, ICE					
	Base Technology Configuration	Port-fuel injected, 4-valve, naturally aspirated gasoline engine, dual variable valve timing	1.4L, I4, 4V, DOHC, NA, PFI, dVVT, ICE					
04	New Technology Configuration	Mild hybrid vehicle, start-stop technology with launch assist and regenerative braking.			2007 Saturn Vue Greenline Start-Stop BAS Technology			
	Base Technology Configuration	Conventional powertrain vehicle (ICE and Transmission) with similar power and torque performance attributes.			2007 Saturn Vue Conventional Powertrain			
05	New Technology Configuration	Power-split hybrid electric vehicle	2010 Ford Fusion Power-Split Cost Models Updated for Europe Subcompact Vehicle Segment HEV Parameters	2010 Ford Fusion Power-Split Cost Models Updated for Europe Compact/Small Vehicle Segment HEV Parameters	2010 Ford Fusion Power-Split Cost Models Updated for Europe Midsize Vehicle Segment HEV Parameters	2010 Ford Fusion Power-Split Cost Models Updated for Europe Midsize/Large Vehicle Segment HEV Parameters	2010 Ford Fusion Power-Split Cost Models Updated for Europe Small/Mid COV/SUV Segment HEV Parameters	
	Base Technology Configuration	Conventional powertrain vehicle (ICE and Transmission) with similar power and torque performance attributes.						
06	New Technology Configuration	Electrically driven air conditioning compressor unit	2010 Ford Fusion AC Compressor Models Updated for Europe Subcompact Vehicle Segment HEV Parameters	2010 Ford Fusion AC Compressor Models Updated for Europe Compact/Small Vehicle Segment HEV Parameters	2010 Ford Fusion AC Compressor Models Updated for Europe Midsize Vehicle Segment HEV Parameters	2010 Ford Fusion AC Compressor Models Updated for Europe Midsize/Large Vehicle Segment HEV Parameters	2010 Ford Fusion AC Compressor Cost Models Updated for Europe Small/Mid COV/SUV Segment HEV Parameters	
	Base Technology Configuration	Mechanically driven air conditioning compressor unit						
07	New Technology Configuration	P2 hybrid electric vehicle	2010 Ford Fusion Power-Split Cost Models Converted to Europe P2 HEV Subcompact Configuration	2010 Ford Fusion Power-Split Cost Models Converted to Europe P2 HEV Compact/Small Configuration	2010 Ford Fusion Power-Split Cost Models Converted to Europe P2 HEV Midsize Configuration	2010 Ford Fusion Power-Split Cost Models Converted to Europe P2 HEV Midsize/Large Configuration	2010 Ford Fusion Power-Split Cost Models Converted to Europe P2 HEV Small/Midsize COV/SUV Configuration	2010 Ford Fusion Power-Split Cost Models Converted to Europe P2 HEV Large SUV Configuration
	Base Technology Configuration	Conventional powertrain vehicle (ICE and Transmission) with similar power and torque performance attributes.						
08	New Technology Configuration	6-speed automatic transmission				2007 Toyota 6-Speed FWD AT (U660E)		
	Base Technology Configuration	5-speed automatic transmission				2005 Toyota 6-Speed FWD AT (U151E)		
09	New Technology Configuration	6-speed wet dual clutch transmission				2009 VW 6-Speed FWD Wet DCT (DQ250)		
	Base Technology Configuration	6-speed automatic transmission				2007 Toyota 6-Speed AT FWD (U660E)		
10	New Technology Configuration	8-speed automatic transmission						2010 ZF 8-Speed RWD AT (8HP70)
	Base Technology Configuration	6-speed automatic transmission						2009 ZF 6-Speed RWD AT (6HP28)
12	New Technology Configuration	8-speed wet dual clutch transmission				8-Speed FWD Wet DCT concept based on DQ250		
	Base Technology Configuration	6-speed wet dual clutch transmission				2009 VW 6-Speed FWD Wet DCT (DQ250)		

Notes: (1) Bases on 2010/2011 OEM published vehicle data (averages are not sales weighted)

B.5 Manufacturing Assumption Overview

For all case studies evaluated, a universal set of assumptions was developed in order to establish a constant framework for all costing. A common framework for all costing permitted reliable comparison of costs between (1) new and baseline technology configurations evaluated in the same analysis, and (2) between competing new technology configurations from two different analyses. In addition, having a good understanding of the analysis boundary conditions (i.e., what assumptions are made in the analysis, the methodology utilized, what parameters are included in the final numbers, etc.), a fair and meaningful comparison can be made between results developed from alternative costing methodologies and/or sources.

Table B-5 captures the primary universal cost analysis assumptions which are applicable to all technology configurations evaluated for the European analysis.

Table B-5: Universal Case Study Assumption Utilized in European Analysis

Item	Description	Universal Case Study Assumptions
1	Incremental Direct Manufacturing Costs	<p>A. Incremental Direct manufacturing cost is the incremental difference in cost of components and assembly, to the OEM, between the new technology configuration and the baseline technology configuration.</p> <p>B. This value does not include Indirect OEM costs associated with adopting the new technology configuration (e.g., tooling, corporate overhead, corporate R&D, etc).</p>
2	Incremental Indirect OEM Costs and the Indirect Cost Multiplier (ICM)	<p>A. Indirect OEM Costs are handled through the application of "Indirect Cost Multipliers" (ICMs) which are applied outside the direct manufacturing cost models. The ICM covers items such as:</p> <ul style="list-style-type: none"> a. OEM corporate overhead (sales, marketing, warranty, etc) b. OEM engineering, design, and testing costs (internal and external) c. OEM owned tooling <p>B. Reference EPA report EPA-420-R-09-003, February 2009, "Automobile Industry Retail Price Equivalent and Indirect Cost Multiplier" for additional details on the development and application of ICM factors.</p>
3	Product/Technology Maturity Level and the Learning Factor	<p>A. Mature technology assumption, as defined within this analysis, includes the following:</p> <ul style="list-style-type: none"> a. Well-developed product design b. High production volume c. Products in service for several years at high volumes c. Significant marketplace competition <p>B. Mature Technology assumption establishes a consistent framework for costing. For example, a defined range of acceptable mark-up rates:</p> <ul style="list-style-type: none"> a. End-item-scrap 0.3-0.7% b. SG&A/Corporate Overhead 6-7% c. Profit 4-8% d. ED&T (Engineering, Design, and Testing) 0-6% <p>C. The technology maturity assumption does not include allowances for product learning within the cost models. Learning curve factors are applied outside the cost models to the calculated incremental direct manufacturing cost for each analysis. The value of the applicable learning factor is dependent on parameters such as technology complexity and market inception date.</p>

Item	Description	Universal Case Study Assumptions
4	Selected Manufacturing Processes and Operations	<p>A. All operations and processes are based on existing standard/mainstream industrial practices.</p> <p>B. No additional allowance is included in the incremental direct manufacturing cost models for manufacturing learning. Learning curve factors, applied to the final incremental direct manufacturing cost, cover both product and manufacturing learning.</p>
5	Annual Capacity Planning Volume	450,000 units
6	Supplier Manufacturing Location	Germany
7	OEM Manufacturing Location	Germany
8	Manufacturing Cost Structure Timeframe (e.g. Material Costs, Labor Rates, Manufacturing Overhead Rates)	2010/2011 production year rates
9	Packaging Costs	<p>A. Calculated on all Tier One (T1) supplier level components.</p> <p>B. For Tier 2/3 (T2/T3) supplier level components, packaging costs are included in T1 mark-up of incoming T2/T3 incoming goods.</p>
10	Shipping and Handling	<p>A. T1 supplier shipping costs covered through application of the Indirect Cost Multiplier (ICM) discussed above.</p> <p>B. T2/T3 to T1 supplier shipping costs are accounted for via T1 mark-up on incoming T2/T3 goods.</p>
11	Intellectual Property (IP) Cost Considerations	Where applicable, IP costs are included in the analysis. Based on the assumption that the technology has reached maturity, sufficient competition would exist suggesting alternative design paths to achieve similar function and performance metrics would be available minimizing any IP cost penalty.
12	Material Cost Reductions (MCRs) on analyzed hardware	Only incorporated on those components where it was evident that the component design and/or selected manufacturing process was chosen due to actual low production volumes (e.g., design choice made to accept high piece price to minimize tooling expense). Under this scenario, assumptions were made and cost analyzed assuming high production volumes.
13	Operating and End-of-Life Costs	No new, or modified, maintenance or end-of-life costs, were identified in the analysis.
14	Stranded Capital or ED&T expenses	No stranded capital or non-recovered ED&T expenses were considered within the scope of this analysis. It was assumed the integration of new technology would be planned and phased in minimizing non-recoverable expenses.

B.6 Application of ICM Factor

The indirect cost multiplier (ICM) was developed by the EPA to address the OEM indirect costs associated with manufacturing new components and assemblies. At a high level, the costs to an OEM, associated with implementation of a new vehicle technology, can be broken into two (2) categories: direct manufacturing costs and indirect costs. The “incremental direct manufacturing cost,” as defined in the context of this project, includes all the direct costs to the OEM to add the new technology configuration to the baseline configuration. The indirect costs (costs associated with OEM research and development, corporate operations, dealership support, sales and marketing material, legal, and OEM owned tooling) are calculated by applying an ICM factor to the direct manufacturing cost.

The ICM was developed by the EPA as an alternative method for accounting indirect costs to the existing retail price equivalent (RPE) methodology. The EPA felt that some of the contributors to RPE, like fixed depreciation costs, health care costs of retired workers, and pension costs, may not be affected by the addition of all new vehicle technologies as a result of imposed regulation. Hence, the EPA developed this modified multiplier referred to as the ICM. In addition, the EPA developed a range of ICMs accounting for differences in technology complexity levels and technology maturity. More details on the development of ICMs can be found in the EPA published report “Automobile Industry Retail Price Equivalent and Indirect Cost Multiplier” EPA-420-R-09-003, February 2009.

For the ICCT analysis, the EPA provided the recommended ICM values. As mentioned, there is a range of ICM factors utilized, dependent on technology complexity and production maturity. The ICM values used for each technology evaluated in the ICCT European analysis are the same as those used by EPA and NHTSA in developing the “Draft Joint Technical Support Document: Proposed Rulemaking for 2017-2025 Light-Duty Vehicle Greenhouse Gas Emission Standards & Corporate Average Fuel Economy Standards”. Reference EPA & NHTSA report EPA-420-D-11-901, November 2011 for additional details on the development and application of ICM factors. **Table B-6** below provides a summary of the ICM factors used in the analysis.

Table B-6: Indirect Cost Multipliers (ICMs) Used in European Analysis

Item	Tech Description	Complexity	Factor Application Period Short Term 2012-"X" Long Term "X+1" - 2025	ICM-Warranty		ICM-Other Indirect Costs		Notes
				Short Term	Long Term	Short Term	Long Term	
1	A/C Compressor	Low2	2018	0.012	0.005	0.230	0.187	Indirect A/C in 2012-2016 FRM
2	6sp AT	Low2	2018	0.012	0.005	0.230	0.187	6-speed AT
3	VVLTD-OHC-I4	Medium2	2018	0.045	0.031	0.343	0.259	Discrete VVLT on all SOHC & DOHC I4 engines (In ICCT analysis used same ICMs for MultiAir VVTL system)
4	DI-I4	Medium2	2018	0.045	0.031	0.343	0.259	I4 PFI converted to I4 DI
5	DI-V6	Medium2	2018	0.045	0.031	0.343	0.259	V6 PFI converted to V6 DI
6	DI-V8	Medium2	2018	0.045	0.031	0.343	0.259	V8 PFI converted to V8 DI
7	V6 DOHC to I4 wT	Medium2	2018	0.045	0.031	0.343	0.259	As above, but with a turbo added in conjunction with the downsizing
8	I4 DOHC to I4 DOHC wT	Medium2	2018	0.045	0.031	0.343	0.259	As above, but with a turbo added in conjunction with the downsizing
9	V8 SOHC 3V to V6 DOHC wT	Medium2	2018	0.045	0.031	0.343	0.259	As above, but with twin turbos added in conjunction with the downsizing
10	8sp AT	Medium2	2018	0.045	0.031	0.343	0.259	8-speed AT incremental to a 4sp AT
11	6sp DCT-wet	Medium2	2018	0.045	0.031	0.343	0.259	6-speed dual clutch transmission (DCT) with a wet clutch
12	Stop-Start	Medium2	2018	0.045	0.031	0.343	0.259	Stop-start system with no regeneration or launch assist (In ICCT analysis used Stop-Start ICMs for BAS Start-Stop system)
13	P2 batt-pack	High1	2024	0.065	0.032	0.499	0.314	P2 HEV battery pack
14	P2 non-batt	High1	2018	0.065	0.032	0.499	0.314	P2 HEV non-battery items
15	Power-split batt-pack	High1	2018	0.065	0.032	0.499	0.314	Power-split HEV battery pack (In ICCT analysis used P2 batt-pack for P2 and Power-split since both assumed Lithium-Ion batteries)
16	Power-split non-batt	High1	2018	0.065	0.032	0.499	0.314	Power-split HEV non-battery items

B.7 Application of Learning Curve Factor

In addition to the application of the indirect cost multiplier, to the incremental direct manufacturing cost, a second factor referred to as “the learning curve factor,” or “experience curve factor,” is also applied. The learning curve factor addresses the anticipated reduction in direct manufacturing costs as a result of “getting smarter” on the product design and /or manufacturing of the product as a function of the number of units produced. The number of units produced can also be represented by the number of years in production. From the product design side, an increase in the familiarity of the product, including interaction within the vehicle systems, allows the product engineer team to refine designs and find lower-cost solutions for similar function. The design modifications may include material substitutions, simplification of parts, reduction of parts, and the adaptation of lower-cost technology alternatives. In addition to design modifications that can drive down the cost, continuous improvements in production can also have significant impact on unit cost reductions. The savings can range from increased efficiencies in various manufacturing operations (e.g., combining operations, reducing part handling, reducing machine takt times) to improving first time yield (i.e.,

reducing quality defects and rework), to the reducing procurement costs of Tier 2 and Tier 3 components.

Similar to the acquisition of the ICMs values, learning factors developed by EPA for the “Draft Joint Technical Support Document: Proposed Rulemaking for 2017-2025 Light-Duty Vehicle Greenhouse Gas Emission Standards & Corporate Average Fuel Economy Standards”, were also utilized in the ICCT analysis.

However, one modification was made in application of learning factors in the ICCT analysis relative to the methodology used by EPA. For new technology configurations which resulted in a savings relative to the baseline technology configuration, the learning factor was held constant at one (1) for all production years evaluated (i.e., 2012 thru 2025). This signifies no change in cost savings as the technology matures. In contrast, the EPA methodology treats new technology configurations with a cost increase or decrease the same. The learning factors are assigned based on technology complexity and maturity; impartial to cost impact. Based on the EPA methodology, a new technology configuration which has a direct manufacturing cost savings over the baseline configuration will have less of a savings in the future relative to the present.

Similar to indirect cost multipliers (ICMs), different curves were applied to different technologies based on several factors including technology complexity and maturity in the market place. **Figure B-10** provides the five (5) learning curves for the various technologies evaluated for production years 2012-2030. For two of the less mature technologies, logarithmic curves are provided showing a more natural depiction of what the decrease in costs may look like over the initial production years. The learning curve factor, applied to the incremental direct manufacturing cost, is based on the applicable technology and production year under evaluation.

Figure B-11 is an example showing the application of the ICM and learning curve factors to the net incremental direct manufacturing cost calculated in case study 0102 (downsizing of a V6 naturally aspirated [NA], port fuel-injected [PFI] gasoline internal combustion engine [ICE] to an I4 turbocharged, gasoline direct injection [GDI] ICE). The gradual trending down of the net incremental technology cost, throughout the curve, is the result of the applied learning curve factors. The learning curve factor starts at one (1) in 2012 and decreases to a value of 0.74 by 2025. The significant offset from the net incremental direct manufacturing cost curve (constant €80) is the result of the applied ICM factors. The constant short term factors are applied between 2012 and 2018 and the long term factors are applied between 2019 and 2025. The sharp drop in the net incremental cost between 2018 and 2019 is the result of the short term to long term factor change.

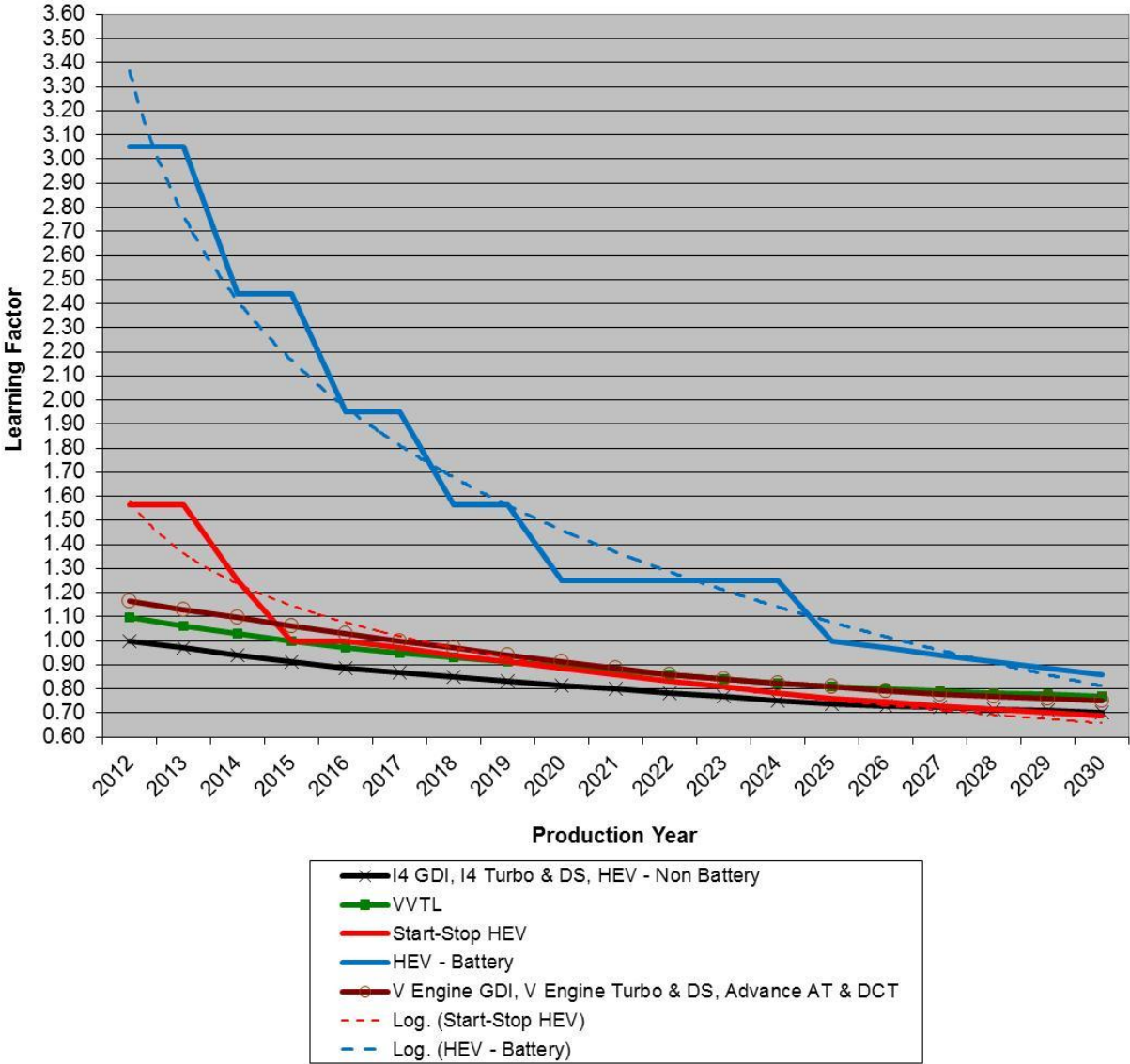

Figure B-10: Learning Curve Factors Applied in European Analysis

**Application of ICM and Learning Curve to Case Study 0102
(V6, NA, PFI Gasoline ICE Downsized to a I4 Turbo GDI ICE)**

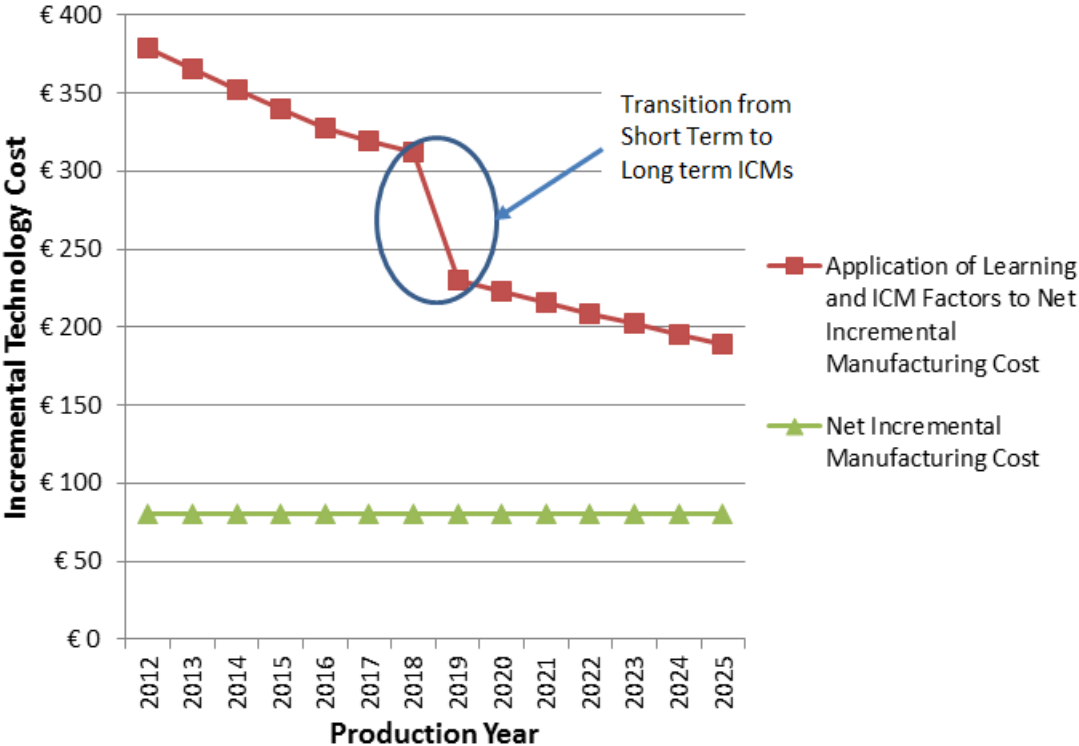

Figure B-11: ICM and Learning Curve Factor Application Example

C. Database Updates

C.1 Database Update Overview

As previously discussed, the cost model databases support the cost models with the required costing data. The process parameter models define items such as the material usage, manufacturing operations, equipment, people, and process times required to fabricate or assemble a component. Conversely, the cost model databases provide costs for the materials, people, and processes. As discussed in **Section 3.2.1**, the North American process parameter models required no updating for the European analysis. This was based on the rationale that, because the U.S. (representing North American) and Germany (representing Europe) are at compatible levels of industrialization on average, no significant differences would exist in the manufacturing and assembly of components.

As a result of social and economic differences between the U.S. and Germany, the cost data residing in the costing databases required updates. For example, labor rates in Germany replaced the U.S. rates in the labor database for similar occupations. Material costs, based on data from Germany, replaced cost developed for similar materials in the U.S. materials database. Key parameters used to develop manufacturing overhead rates (e.g., equipment costs, facility floor space costs, utility expenses, annual available production hours) were updated with values from Germany to develop corresponding Germany manufacturing overhead rates. The European database set is developed specifically based on Germany's 2010/2011 economic conditions.

There are five (5) databases total, containing a total of eight (8) different cost elements/factors (material, labor, manufacturing overhead, end-item-scrap, SG&A, profit, ED&T, and packaging). In the FEV costing process, the direct manufacturing cost is the summation of total manufacturing costs (TMC) plus mark-up plus packaging. The total manufacturing cost consists of material, labor, and manufacturing overhead costs; a database exists for each of these cost factors. The mark-up consists of end-item scrap, selling, general and administrative costs (SG&A), profit, and engineering, design and testing (ED&T). A single database addresses all four (4) mark-up factors. The fifth database is the packaging database.

In the sections that follow, a brief overview of each database and the conversion from U.S. to Germany values is discussed. For a detailed review of the development of the costing database and how they are integrated into the costing process, please reference the "Light-Duty Technology Cost Analysis Pilot Study" EPA-420-R-09-020 (<http://www.epa.gov/OMS/climate/420r09020.pdf>).

C.2 Material Database

C.2.1 Material Database Overview

The Material Database houses specific material prices and related material information required for component cost estimating. The primary information related to each material listed includes the material name, standard industry identification (e.g., AISI or SAE nomenclature), stock form, typical automotive applications, pricing per kilogram, annual consumption rates, and source references. In addition, for selected materials, dependent on the applicability, processing parameters, thermal properties and additional information on stock form (e.g., tube wall thickness tolerance, coil thickness tolerance) are included in the database.

In the database, three (3) cost categories are possible for each material: low, average, and high costs/kilogram. When new pricing is sought for a material, an attempt is made to gather several cost data points. A cross-function team reviews and assesses the material pricing data points and attempts to assign pricing to each pricing category. The pricing contained in the FEV material database is based on high-volume manufacturing (i.e., >450K units per year). For the majority of analyses conducted by FEV, the average pricing category is generally utilized. The high and low pricing values provide data points for sensitivity analyses. When different project boundaries exist (e.g., low production volumes), new databases are created to suit the project assumptions.

The pricing data contained in the database is derived from various sources: publicly available data, raw material supplier base, Tier 1 and Tier 2 automotive parts manufacturer supplier base, internal subject matter experts, or is calculated using raw material element pricing.

For example, much of the ferrous and non-ferrous alloy pricing was acquired from sources including the U.S. Geological Survey (USGS), MEPS (previously Management Engineering & Production Services), Metal-Pages, London Metal Exchange, estainlesssteel.com, and Longbow.

Resin pricing was also obtained from sources such as Plastics News, Plastics Technology Online, Rubber and Plastics News, and IDES (Integrated Design Engineering Systems). Several other sources were used in this research as outlined in the database.

Though material prices are often published for standard materials, prices for specialized material formulations and/or those having a nonstandard geometric configuration (e.g., length, width, thickness, cross-section) are not typically available. Where pricing is not available for a given material with a known composition, two approaches are used: industry consultation and composition analysis.

Industry consultation mainly takes the form of discussions with subject matter experts familiar with the material selection and pricing used in the products under evaluation to acquiring formal quotes from raw material suppliers. For example, much of the NiMH

battery material pricing was acquired from supplier quotes at the capacity planning volumes stated in the analysis.

In those cases where published pricing data was unavailable and raw material supplier quotes could not be acquired, a composition analysis was used. This was achieved by building prices based on element composition and applying a processing factor (i.e., market price/material composition cost) derived from a material within the same material family. The calculated price was compared to other materials in the same family as a means to ensure the calculated material price were directionally correct.

Obtaining prices for unknown proprietary material compositions, such as powder metals, necessitated a standardized industry approach. In these cases, manufacturers and industry market research firms were consulted to provide generic pricing formulas and pricing trends. Their price formulas were balanced against published market trends of similar materials to establish new pricing trends.

Resin formulations are also available with a variety of fillers and filler content. Some pricing data is available for specific formulations; however, pricing is not published for every variation. This variation is significant since many manufacturers can easily tailor resin filler type and content to serve the specific application. Consequently, the database has been structured to group resins with common filler into ranges of filler content. For example, glass-filled Nylon 6 is grouped into three (3) categories: 0 to 15 percent glass-filled, 30 to 35 percent glass-filled, and 50 percent glass-filled, each with their own price point. These groupings provide a single price point as the price differential within a group (0 to 15 percent glass-filled) is not statistically significant.

C.2.2 Material Database Updates for European Analysis

The creation of a European materials database established from the existing North American databases was relatively straight-forward. As shown in **Figure C-1**, the first step in the process was to match the North American material specifications in the database with European equivalents. Once a corresponding European specification was identified for each material in the database, the FEV team in Aachen Germany began the processes of assigning material pricing. Four (4) methods of establishing costs were utilized (the order of preference presented below):

1. Transfer material costs from FEV Aachen internal databases with similar boundary conditions (i.e., high production volume, 2010/2011 pricing values).
2. Acquire rates from publicly available data, raw material supplier base, Tier 1 and Tier 2 automotive parts manufacturer supplier base, and internal subject matter experts.
3. Develop prices based on known composition/element and processing cost. As explained previously, this was achieved by building prices based on element composition and applying a processing factor (i.e., market price/material composition cost) derived from a material within the same material family. The calculated price was compared to other materials in the same family as a means to ensure the calculated material price was directionally correct.
4. In cases where comparable European specifications and/or European pricing could not be found, the project currency exchange rate was applied to the values captured in the North American database.

Once the European values were established, the values were entered into a European Materials Database identical in format to the existing North American database. The material IDs (e.g., “Al 319.0, Cast”, “C Steel-1008/1010 Coil”, “TP-PA6 GF40”) automatically connect the pricing in the database files to the cost models (i.e., MAQS worksheets), that is once the appropriate links are established. By not changing the material IDs between the EPA and ICCT study, it was relatively straight-forward to bring in the European values into the cost models.

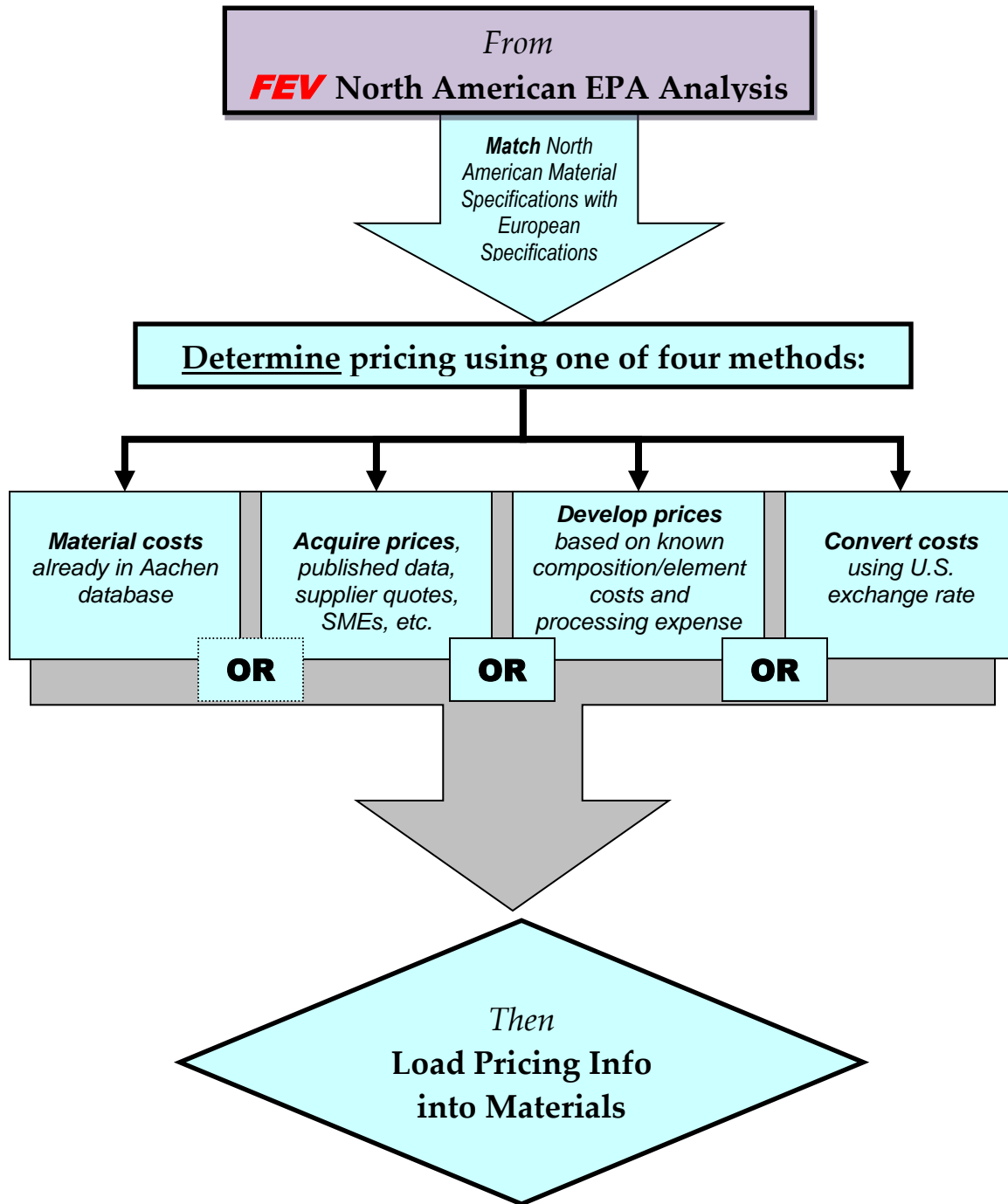

Figure C-1: Material Database Conversion Process Flow

C.3 Labor Database

C.3.1 Labor Database Overview

The Labor Database contains all the standard occupations and associated labor rates required to manufacture automotive parts and vehicles. All labor rates throughout the EPA cost analysis are referenced from the established Labor Database. U.S. hourly wage rate data used throughout the study, with exception of fringe, is acquired from the United States Bureau of Labor Statistics (BLS). For the EPA analysis, mean hourly wage rates were chosen for each occupation, representing an average wage across the United States.

Each standard production occupation found in the Labor Database has a standard occupation classification (SOC) number, title, labor description, and mean calculated hourly labor rate. Only “direct” production occupations are listed in the database. Team assemblers and forging, cutting, punching, and press machine operators are all considered direct production occupations. There are several tiers of manufacturing personnel supporting the direct laborers that need to be accounted for in the total labor costs: quality technicians, process engineers, lift truck drivers, millwrights, electricians, etc. A method typically used by the automotive industry to account for all of these additional “indirect labor” costs, and the one chosen for this cost analysis, is to calculate the contribution of indirect labor as an average percent of direct labor, for a given production occupation, in a given industry sector. The indirect labor contribution is accounted for with two (2) separate factors: indirect laborers (e.g., material handling, quality technicians, 1st line supervisors, process engineers) and maintenance, repair, and other laborers (MRO) (e.g., millwrights, electricians, operations engineering).

For example, the mean hourly wage for a mold press operator in the United States is \$11.38/hour (Year 2010). The indirect operator contribution is 66% and the MRO is 23%. Therefore, the combined hourly wage would be \$21.51/hour [$\$11.38 + \$7.51 (\$11.38 * 0.66) + \$2.62 (\$11.38 * 0.23)$].

The BLS Database provides labor wage data, rather than labor rate data. In addition to what direct and indirect laborers are paid, there are several additional expenses the employer must cover in addition to the employee base wage. This analysis refers to these added employer expenditures as “fringe.” Examples of expenses captured as part of fringe include company medical and insurance benefits, pension/retirement benefits, government directed benefits, vacation and holiday benefits, shift premiums, and training.

Fringe applies to all manufacturing employees. Therefore the contribution of fringe to the overall labor rate is based on a percentage of direct, indirect and MRO labor. Two (2) fringe rates were used in the EPA analysis: 52% for supplier manufacturing, and 160% for OEM manufacturing.

Continuing with the previous injection mold operator example, the “loaded” hourly labor rate applied to an injection mold press operator (Tier 1 facility) would be \$32.70/hour [$(\$21.51 + (21.51 * 0.52))$]

C.3.2 Labor Database Updates for European Analysis

Two (2) primary sources were used in the conversion of the United States labor database to an equivalent Germany labor database: (1) FEV Aachen Germany internal cost engineering databases, and (2) published documents from the Germany Federal Statistical Office.

The database conversion process can be defined in the following eleven (11) steps

Step 1 Formal Trainings/Apprentice Profession Definition: Identify German official apprentice professions including profession codes, similar to Standard Occupation Classification (SOC) system Codes found in the United States Bureau of Labor Statistics North American Industry Classification System.

Step 2 Gathering Labor Data: Gathering labor data for all professions from FEV Aachen Database and Federal Statistical Office Germany. In Germany, for each occupation, ability groups exist. Data was acquired for all ability groups, for each occupation.

Step 3 Monthly to Hourly Rate Conversion: The German databases contained monthly rates requiring a conversion from monthly rates to hourly rates by definition of average monthly hours worked.

Step 4 Match U.S. SOC system codes with German Occupation Equivalent: Match US BLS SOC system codes accordingly with equivalent German occupations.

Step 5 Match U.S. Direct Labor Description with German Ability Groups: Within the U.S. labor database, each direct labor title is supplemented by a brief labor description. With reference to this description, the most applicable German ability group is matched.

Step 6 Uploading of European Direct Labor Wages into the Database: Upon successful matching of U.S. SOC codes and labor description with German professions and ability groups, German direct labor rates were uploaded into the European labor database.

Step 7 Development of Scaling Factor of Supplier Versus OEM Direct Labor Rates: The Federal Statistical Office in Germany does not separate occupation wage data based on industry type similar to the North American Industrial Classification System (NAICS) used by the U.S. BLS. In the EPA analyses the same occupations exist for Automotive Parts Manufacturers (NAICS 336300) and Automotive Vehicle Manufacturers (NAICS 336100). However, the wages for the same occupation in each industry are different. In general, the mean wages in the NAICS 336300 industry are approximately 30% less than the mean wages for the same occupations in the NAICS 336100 industry (2010 mean wage data does not include fringe allowances).

As a result of the labor data not existing in the same format from the German Federal Statistical Office, the FEV team developed scaling factors based on the differences found between the occupations in the two industries used in the US EPA analysis. These scaling factors were applied to the direct wage numbers loaded into the database as identified in **Step 6** above.

Step 8 Adjust Labor Wage Data for 2010 Production Year: Since most of the available wage data and surveys were taken during the 2006-2008 timeframe, an annual adjustment of 2%/year was applied to bring the values in-line with the analysis timeframe (2010/2011).

Step 9 Indirect Labor Rate Ratio (ILRR) Application: It is estimated that German factories/enterprises are organized similar to U.S. factories/enterprises; therefore, no adjustments were made to the indirect labor contributions. The same values are used for both the North American and European Labor Databases.

Step 10 Maintenance Repair and Other (MRO) Labor Rate Ratio (MLRR) Application: It is estimated that MRO efforts in the U.S. are similar to German production machinery maintenance and repair efforts. Therefore, U.S. values were also carried over to the European labor database.

Step 11 Application of Fringe Allowance: Because differences exist related to the type of benefits, and binning of benefits, between Germany and the U.S., a new fringe calculation was made for the European labor database. The fringe allocation for Germany was determined as an average value based on marketed surveys between 1996 and 2009 for 24 different industry branches/classifications. A value of 32.91% was used for both supplier (NAICS 336300) and OEM (NAICS 336100) industries.

Once the new fringe values were loaded into the European database, final calculations were made establishing the European labor rates to be used in the various cost models. As with the material database, the labor classification IDs remained the same for both the North American and European Databases, making uploading into the cost models a manageable task.

C.4 Manufacturing Overhead (Burden) Database

C.4.1 Manufacturing Overhead Database Overview

The Manufacturing Overhead Database contains the manufacturing overhead rates (sometimes referred to as “burden rates,” or simply “burden”) associated with various types of manufacturing equipment required to manufacture automotive parts and vehicles. Along with material and labor costs it forms the total manufacturing cost (TMC) to manufacture a component or assembly.

As shown in the lists below, manufacturing overhead includes both fixed and variable costs. Generally, the largest contributor to the fixed burden costs are the investments associated with primary and process support equipment. Utility usage is typically the single largest contributor to the variable burden rate.

Burden costs include:

- primary and process support manufacturing equipment depreciation
- plant office equipment depreciation
- utilities expense
- insurance (fire and general)
- municipal taxes
- plant floor space (equipment and plant offices)
- maintenance of manufacturing equipment (non-labor)
- maintenance of manufacturing building (general, internal and external, parts, and labor)
- operating supplies
- perishable and supplier-owned tooling
- all other plant wages (excluding direct, indirect and MRO labor)
- returnable dunnage maintenance (includes allowance for cleaning and repair)
- intra-company shipping costs

Because there is very limited data publicly available on manufacturing overhead rates for the industry sectors included in this analysis, overhead rates were developed from a combination of internal knowledge at FEV and Munro, supplier networks, miscellaneous publications, reverse costing exercises, and “ground-up” manufacturing overhead calculations.

For ground-up calculations, FEV created a generic “Manufacturing Overhead Calculator Template.” This template is equally applicable to Germany calculations. The template consists of eight (8) sections:

- General Manufacturing Overhead Information
- Primary Process Equipment
- Process Support Equipment
- General Plant & Office Hardware/Equipment
- Facilities Cost
- Utilities
- Plant Salaries

- Calculated Hourly Burden Rate.

As discussed, multiple methods of arriving at burden rates were used within the cost analysis. Every attempt was made to acquire multiple data points for a given burden rate as a means of validating the rate. In some cases, the validation was accomplished at the final rate level. In other cases, multiple pieces of input data used in the calculation of a rate were acquired as a means of validation.

C.4.2 Manufacturing Overhead Updates for European Analysis

To transform the manufacturing overhead values from North America to Europe, an updated set of input parameters, based on data from Germany, were re-loaded into the Burden Rate calculator templates.

In the **General Manufacturing Overhead** section, new values were entered for the yearly operating capacity (4,500hrs Germany; 4,700hrs U.S.) and Operation Efficiency (90% Germany, 85% U.S.). No changes were made to parameters such as equipment utilization, equipment depreciation periods, and facility size.

In the **Primary Process Equipment** and **Process Support Equipment** cost sections of the calculator template, equipment costs were converted from U.S. dollars to Euros. All secondary equipment contribution costs remained the same with the exception of property tax (0% Germany, 0.65% U.S.). Secondary contribution costs are based on percentages of primary and process support equipment costs as shown in the Burden Rate Calculator excerpt (**Figure C-2**).

18	Primary Process Equipment (PPE) Life Expectancy	Years	15
19	Average Annual Personal Property Tax	%	0.65%
20	Average Annual Equipment Insurance	%	0.32%
21	Facility Preparation Expense	%	12.00%
22	Equipment Installation Expense	%	1.00%
24	Equipment Set-up and Run-off Expense	%	5.00%
25	Maintenance, Repair, Other (MRO) Part Allowance	%	3.00%
26	Perishable Good Allowance	%	1.50%

Figure C-2: Burden Rate Calculator Excerpt - Primary Equipment Secondary Contributions (U.S. Analysis Default Values)

There were no modifications required in the **General Plant & Office Hardware/Equipment** section of the calculator template. The contribution of equipment usage toward general plant and office hardware/equipment was accounted for as a percentage of primary and process support equipment costs. It is estimated the percentage would be approximately the same for both the U.S. and Germany burden rate calculations.

The **Facilities Cost** section assigns a contribution of the facility costs toward the primary and process support equipment based on the floor space utilization. An allowance was also made for the contribution toward General Plant & Office Equipment/Hardware Floor space utilization. In the conversion process (U.S. to Germany burden rates), no changes were made on quantity of floor space utilization. However, the cost per square foot of facility space was modified (Germany €90/square meter, U.S. \$11.50/square foot).

In the **Utilities** section, updates were made to each of the utility costs. Average utility unit costs for Germany replaced the existing U.S. parameters. **Figures C-3** and **Figure C-4** show the North American and Europe utility rates used in the analysis.

41	Cost of Electricity	\$/kW*hour	\$0.07170
42	Cost of Natural Gas	\$/ft ³	\$0.00664
43	Cost of Water	\$/Gallon	\$0.00100
44	Cost of Compressed Air	\$/ft ³	\$0.02500
45	Cost of Oil (Fuel)	\$/Gallon	\$1.10476
45	Cost of Coke (Fuel)	\$/Ton	\$190.00

Figure C-3: Utility Costs used in EPA North American Analysis

41	Cost of Electricity	€/kWh	€ 0.097
42	Cost of Natural Gas	€/kWh	€ 0.041
43	Cost of Water	€/m ³	€ 2.50
44	Cost of Compressed Air	€/m ³	€ 1.19
45	Cost of Oil (Fuel)	€/l	€ 0.50
45	Cost of Coke (Fuel)	€/t	€ 100

Figure C-4: Utility Costs used in ICCT Europe Analysis

The **Plant Salaries** section of the calculator template covers the cost of all the salary workers not directly involved in the production process of a given component or assembly. This category includes personnel such as the plant manager, quality manager, procurement manager, facility administration, and human resource personnel. In the Burden rate calculator a salary cost is calculated per square foot of facility space. Based on the primary and process support equipment floor space utilization, a salary contribution is assigned. In the calculation of European burden rates, German production facilities salaries replaced existing U.S production facility salaries. No modifications were made in the calculation methodology to assign a salary labor cost per square foot of production facility space.

Once all the new Germany cost parameters were loaded into the calculator templates, new European burden rates were derived.

C.5 Mark-Up Database

C.5.1 Mark-up Database Overview

All mark-up rates for Tier 1 and Tier 2/3 automotive suppliers referenced throughout the cost analysis can be found in the Mark-up Database, except in those cases where unique component tolerances, performance requirements, or other unique feature dictated a special rate. In cases where a mark-up rate is “flagged” within the costing worksheet, a note is included which describes the assumption differences justifying the modified rate.

For the cost analysis study, four (4) mark-up sub-categories were used in determining an overall mark-up rate: (1) end-item scrap allowance, (2) SG&A expenses, (3) profit, and (4) ED&T/R&D expenses. Additional details for each subcategory are discussed below.

End-Item Scrap Mark-up is an added allowance to cover the projected manufacturing fall-out and/or rework costs associated with producing a particular component or assembly. In addition, any costs associated with in-process destructive testing of a component, or assembly, are covered by this allowance. As a starting point, scrap allowances are estimated to be between 0.3% and 0.7% of the TMC within each primary manufacturing processing group. The actual assigned value for each category is an estimate based on complexity, and to a lesser degree, size of the primary processing equipment.

When published industry data or consultation with an industry expert improves estimate accuracy for scrap allowance associated with a generic manufacturing process (e.g., 5% for sand casting, investment casting), the Mark-up Database is updated accordingly. In cases where the manufacturing process is considered generic, but the component performance requirements drive a higher fall-out rate (e.g., 25% combined process fallout on turbocharger turbine wheels), then the scrap mark-up rate would only be adjusted in the Manufacturing Assumption Quote Summary (MAQS) worksheet.

Selling, General, and Administrative (SG&A) Mark-up is also referred to as corporate overhead or non-manufacturing overhead costs. Some of the more common cost elements of SG&A are:

- Non-manufacturing, corporate facilities (building, office equipment, utilities, maintenance expenses, etc.)
- Corporate salaries (President, Chief Executive Officers, Chief Financial Officers, Vice Presidents, Directors, Corporate Manufacturing, Logistics, Purchasing, Accounting, Quality, Sales, etc.)
- Insurance on non-manufacturing buildings and equipment
- Legal and public relation expenses
- Recall insurance and warranty expenses
- Patent fees
- Marketing and advertising expenses
- Corporate travel expenses

SG&A, like all mark-up rates, is an applied percentage to the Total Manufacturing Cost. The default rates for this cost analysis range from 6% to 7% within each of the primary processing groups. The actual values, as with the end-item scrap allowances, vary within these ranges based on the complexity and size of the part, which in turn is reflected in the complexity and size of the processing equipment. To support the estimated SG&A rates (which are based on generalized OEM data), SG&A values were extracted from publicly traded automotive supplier 10-K reports.

Profit Mark-up is the supplier's or OEM's reward for the investment risk associated with taking on a project. On average, the higher the investment risk, the larger the profit mark-up that is sought by a manufacturer.

As part of the assumptions list made for this cost analysis, it was assumed that the technology being studied was mature from the development and competition standpoint. These assumptions are reflected in the conservative profit mark-up rates which range from 4% to 8% of the Total Manufacturing Cost. The profit mark-up ranges selected from this cost analysis were based on generalized historical data from OEMs and suppliers.

As detailed with the preceding mark-up rates, the actual assigned percentage was based on the supplier processing equipment complexity and size capabilities.

ED&T Mark-up: the ED&T used for this cost analysis is a combination of "Traditional ED&T" plus R&D mark-up.

Traditional ED&T may be defined as the engineering, design, and testing activities required to take an "implementation ready" technology and integrate it into a specific vehicle application. The ED&T calculation is typically more straight-forward because the tasks are predefined. R&D, defined as the cost of the research and development activities required to create a new (or enhance an existing) component/system technology, is often independent of a specific vehicle application. In contrast to ED&T, pure R&D costs are very difficult to predict and are very risky from an OEM and suppliers perspective, in that these costs may or may not result in a profitable outcome.

For many automotive suppliers and OEMs, traditional ED&T and R&D are combined into one (1) cost center. For this cost analysis, the same methodology has been adopted, creating a combined traditional ED&T and R&D mark-up rate simply referred to as ED&T.

Royalty fees, as the result of employing intellectual property, are also captured in the ED&T mark-up section. When such cases exist, separate lines in the Manufacturing Assumption & Quote Summary (MAQS) worksheet are used to capture these costs. These costs are in addition to the standard ED&T rates. The calculation of the royalty fees are on a case-by-case basis. Information regarding the calculation of each fee can be found in the individual MAQS worksheets where applicable.

In **Table C-1** a summary is provided of the default mark-ups are the values used in the EPA analysis .

Table C-1: Standard Mark-up Rates Applied to Tier 1 and Tier 2/3 Suppliers Based on Complexity and Size Ratings

Primary Manufacturing Equipment Group	End Item Scrap Mark-up	SG&A Mark-up	Profit Mark-up	ED&T Mark-up	Total Mark-up
Tier 2 /3 – High Complexity, Large Size	0.7%	7.0%	8.0%	2.0%	17.7%
Tier 2 /3 – Moderate Complexity, Medium Size	0.5%	6.5%	6.0%	1.0%	14.0%
Tier 2 /3 – Low Complexity , Small Size	0.3%	6.0%	4.0%	0.0%	10.3%
Tier 1 Complete System/Subsystem Supplier (System/Subsystem Integrator)	0.7%	7.0%	8.0%	6.0%	21.7%
T1 High Complexity Component Supplier	0.7%	7.0%	8.0%	4.0%	19.7%
T1 Moderate Complexity Component Supplier	0.5%	6.5%	6.0%	2.5%	15.5%
T1 Low Complexity Component Supplier	0.3%	6.0%	4.0%	1.0%	11.3%

C.5.2 Mark-Up Database Updates for European Analysis

In the ICCT analysis the type of suppliers manufacturing automotive parts in Europe are considered to be similar to the U.S. infrastructure. Therefore, the U.S. mark-up database was not modified for the European analyses.

C.6 Packaging Database

C.6.1 Packaging Database Overview

The Package Database contains all the packaging specifications and costs utilized in the EPA analysis. In general, most packaging options are based on standard AIAG (Automotive Industry Action Group) specifications utilizing returnable dunnage. Unlike the material, labor, and manufacturing overhead, and the mark-up databases, which have direct automated links to the manufacturing assumption and quote summary (MAQS) worksheets, the packaging databases require manual transferal of packaging assumptions and costs into the MAQS worksheets.

For a given application the cost engineer will reference the packaging database to find the best available packaging option that suits the component under investigation. Packaging

material costs are manually transferred into the MAQS worksheets. Within the MAQS worksheet, calculations are in reference to the amount of packing required based on pre-established boundary conditions for Supplier, Customer, and In-transit Inventory Requirements (Weeks). The end result is a cost-per-unit calculation for packaging.

C.6.2 Packaging Database Updates for European Analysis

For the European analysis, no assumptions changes were made relative to packaging. Because the values are hardcoded in the MAQS worksheets, the U.S. packaging databases were not modified. Instead, packing costs were transformed into Euros directly in the MAQS worksheets by applying the project U.S. dollar to Euro exchange rate. Packing costs are insignificant in the analyses as they generally represent less than 0.25% of the overall cost impact.

D. Manufacturing Assumption and Quote Summary Worksheet & Cost Model Analysis Updates

D.1 Overview of MAQS Worksheet

As summarized in the previous sections, the core costing models FEV employs consist of several processes and documents integrated together to develop cost. Costs are developed at all levels: component, assembly, sub-subsystem, subsystem, system, and vehicle. The Manufacturing Assumption and Quote Summary (MAQS) worksheet is the document used in the cost analysis process to compile all the known cost data, add any remaining cost parameters, and calculate the final component cost (**Step 9, Figure B-5**). In addition, the MAQS worksheet details the cost build-up of components into assemblies, assemblies into sub-subsystems, sub-subsystems into subsystems, subsystems into systems, and systems into a vehicle. All key manufacturing cost information can be viewed in the MAQS worksheets at any vehicle level.

Additional details on the pertinent sections of the MAQS worksheet can be found in Appendix G.2.

D.2 Overview of MAQS Changes

Minor modifications were required to the MAQS worksheets to support the conversion of the U.S. to Germany cost models. Much of costing data in the MAQS worksheets is automatically uploaded directly from the databases. Thus, once Germany costing databases links were made to the MAQ worksheets, all linked manufacturing rates (e.g. material, labor, and manufacturing overhead costs) were pulled into the models representing the correct Germany rates. However, for certain items, namely purchased part and packaging costs, the values were hard-coded directly into the worksheets. MAQS worksheets having hardcode values required manual conversion of component costs from U.S. to Euro currency. This was accomplished by applying a common Euro to U.S. exchange factor of 1:1.43. Other modifications made, which were considered more superficial, included updating the MAQS worksheets with the correct currency symbols.

D.3 Overview of CMAT

Cost Model Analysis Templates (CMATs) are developed to consolidate and organize the several layers of costing data originating from the MAQS worksheets. For each design level (e.g., Vehicle, System, Subsystem, Sub-subsystem, Assembly) there is the potential for a CMAT, dependent on the particular analysis (**Steps 11-13, Figure B-5**).

The CMATs allow for a quick assessment of cost build-up at one design level below the CMAT level under review. For example, in a vehicle CMAT, the cost impact of each system is presented. As shown in **Figure B-6**, the vehicle CMAT includes cost impact

summaries for each system, including the engine, transmission, body, and suspension. The engine system CMAT includes cost impact summaries for each subsystem within the engine system (e.g., crank-drive, cylinder block, cylinder head, valvetrain). Similarly, the crank-drive subsystem would provide summaries for the connecting rod, piston, crankshaft and flywheel sub-subsystems.

Cost element resolutions (i.e., material, labor, manufacturing overhead as well as mark-up contributions) are maintained at all CMAT levels. In addition, for differential cost analyses, such as those employed in EPA and ICCT technology cost comparison analyses, the new technology, baseline technology, and differential cost summaries are all provided in a single CMAT worksheet.

D.4 Overview of CMAT Changes

The majority of the CMATs are either directly or indirectly linked to MAQS worksheets. As the MAQS worksheets values are updated with European values, the CMATs are automatically updated (i.e., component MAQS worksheets link to assembly MAQS worksheets, which link to Sub-subsystem CMATs, which link to Subsystem CMATs, which link to System CMATs, which link to vehicle CMATs). In some cases, hard values are coded directly into the CMATs which require a manual conversion of part costs from U.S. dollars to Euros using the project analysis exchange rate of €1:1.43.

Similar to the MAQS worksheets, the currency symbols were updated in all the CMAT worksheets for each case study.

E. Case Study Results

Provided here are the net incremental manufacturing costs for the various technology configurations and vehicle segments evaluated. For each evaluation, the costs are provided both as incremental direct manufacturing costs and net incremental manufacturing (direct + indirect) costs which includes the addition of the Indirect Cost Multiplier (ICM) Factor as well a Learning factor. Shown in a separate table, for each technology evaluated, are the ICM and learning factors employed in each analysis for 2012, 2016, 2020, and 2025.

Prior to presenting the cost impact results for each analysis, a brief review of the technology evaluated is provided. Complete details on each technology can be found in the respective EPA reports (Reference **Table B-3** for a complete list of the published reports and corresponding internet links). Provided below are excerpts from the published EPA work.

E.1 Engine Technology Configurations Evaluated

E.1.1 Engine Technology Overview

Two (2) types of internal combustion engine technologies were evaluated as part of this work scope: (1) downsized (DS), turbocharged (TC), gasoline direct injection (GDI) engines, and (2) variable valve timing and lift (VVTL) valvetrain technology. Both technologies were initially evaluated as part of the EPA work assignment.

E.1.1.1 DS, TC, GDI Engines

For three of the DS, TC, GDI engine technology case studies (#0102, #0103, and #0106), physical hardware was evaluated to derive the incremental direct manufacturing costs. As discussed in **Section B.4.2**, and shown **Table B-4**, the three aforementioned engine sizes were applicable for vehicle segments in both the U.S. EPA study and ICCT European study. For two of the case studies (#0100, #0101) a scaling methodology, applied to components and costs developed from detailed teardown analyses, was utilized to calculate the incremental direct manufacturing costs unique to vehicle segments in the ICCT European analysis. Additional details for each case study are summarized below stating with the detailed analyses.

Case Study #0102 (I4 Downsized to Smaller I4)

Case study #0102 compared a stoichiometric, downsized, turbocharged, gasoline direct injection (GDI) to an equivalent performance conventional I4 engine. The hardware chosen to represent the new technology configuration was the 2007 BMW/PSA Peugeot Citroën Prince (Engine option for 2007 Mini Cooper S) 1.6L I4, four (4) valve, dual overhead cam, turbocharged, direct injection engine (172 hp). The engine selected to represent the baseline configuration was the 2007 Chrysler GEMA 2.4L I4, four (4)

valve, dual overhead cam, naturally aspirated, port fuel injected engine (173 hp). See **Table E-1** for additional comparison details.

At the time of the analysis, the Prince engine only had intake variable valve timing (i-VVT). Since dual VVT was assumed to be a standard technology present on all new mainstream engines (part of EPA original study boundary conditions), adjustments were made in the analysis to account for an exhaust cam phaser and its associated hardware.

Case Study #0103 (V6 Downsized to I4)

Case Study #0103 analyzed the direct incremental manufacturing cost for downsizing from a conventional 3.0L, V6, 4-V, DOHC, d-VVT, NA, PFI engine to a 2.0L, I4, 4-V, DOHC, d-VVT, turbocharged, GDI engine. The performance specifications for both engine configurations were considered to be equivalent with a maximum power output of approximately 225 hp and maximum torque of approximately 210 lb.-ft

Note that in this analysis, neither the new nor base engine actual hardware had d-VVT. Both sets of hardware consisted only of intake-VVT. However, as part of the overall study assumptions, both technologies were assumed to have d-VVT.

For the conventional/baseline engine configuration, a 2008 Ford Cyclone Duratec 35 (i.e., 3.5L V6) engine was used in combination with a 2008 Ford Mondeo Duratec 30 (i.e., 3.0L V6) engine. The 3.5L Duratec engine was the principal hardware referenced in this analysis, with the 3.0L Duratec engine primarily used to support size and weight scaling of the 3.5L V6 engine to a 3.0L V6 equivalent. This approach was taken for two (2) main reasons: 1) the 3.5L Duratec is a relative new engine (launched in 2007 timeframe, winner of 2007 Ward's Top 10 Best Engines) and, as such, is considered to contain some of the latest design and manufacturing advances for conventional V6 engines; and 2) much of this same base engine cost analysis could be reused in Case Study #0106 (5.4L V8, NA, PFI downsized to a 3.5L V6, Turbo, GDI engine), reducing analysis time.

For the new technology configuration, the 2007 BMW/PSA Peugeot Citroën Prince 1.6L I4, Turbo, GDI engine (used in the 2008 Mini Cooper, S) was selected as the lead hardware, scaled up to a 2.0L I4, Turbo, GDI equivalent. Both the Chrysler GEMA 2.4L, I4, NA, PFI engine and GM Family II, Ecotec, 2.0L, I4, Turbocharged, GDI engine were used for size and weight scaling (e.g., pistons, connecting rods, cylinder head), feature counts (e.g., valve cover fasteners, oil sump fasteners), as well as for costing selected items not captured within the 1.6L I4 BOM (e.g., balance shaft). Because the 1.6L I4, Prince engine was used in a previous study (case study #0102), selected cost models for this previously completed work could be reprocessed with updated function and performance specifications, reducing analysis time. See **Table E-2** for additional comparison details.

Case Study #0106 (V8 Downsized to V6)

Case Study #0106 analyzed the direct incremental manufacturing cost for downsizing from a conventional 5.4L, V8, 3-V, SOHC, VVT, NA, PFI engine to a 3.5L V6, 4-V, DOHC, d-VVT, turbocharged, GDI engine.

For the conventional/baseline engine configuration, a 2008 Ford Modular 5.4L V8 engine was selected. Standard features of this engine include a cast-iron block, forged crankshaft, aluminum heads, variable valve timing, and hydraulic, roller finger valve lifters. The maximum power output rating is 300 hp @ 5000 rpm with a maximum torque of 365 lb.-ft. @ 3750 rpm.

For the new technology configuration, a 2008 Ford Cyclone Duratec 35 (i.e., 3.5L V6) base engine was selected for the foundation of the analysis. Utilizing the project team's expertise, published data on Turbo, GDI, V6 engine architectures, surrogate component data from existing benchmarking evaluations, and previously completed cost studies (i.e., case study #0102 and #0103), the project team developed a 3.5L V6, Turbo, GDI engine Bill of Materials (BOM). In regards to a target performance specification, the Ford EcoBoost engine (3.5L V6, 4-V, DOHC, i-VVT, Turbo, GDI, engine) specification was used as a surrogate; maximum 355 hp @ 5000 rpm and 350 lb.-ft. @ 3500 rpm.

Features of the 3.5L V6, Turbo, GDI fuel induction subsystem include a direct rotary drive, swash plate design, high-pressure fuel pump servicing six (6) side-mounted solenoid injectors (7-hole type), with a maximum operating pressure of 150 bar. The air induction subsystem features twin, single-scroll turbocharger assemblies. Each turbocharger assembly has a vacuum-actuated waste gate, an electronically-actuated anti-surge valve, and a water-cooled, pressure-lubricated bearing housing. The maximum exhaust gas inlet temperature permitted at the turbine inlet is 950°C. Compressed air leaving the turbocharger assemblies is cooled prior to reaching the intake manifold via an air-to-air heat exchanger. See **Table E-3** for additional comparison details.

Case Study #0100 (I4 Downsized to I3) and #0101 (I4 Downsized to Smaller I4)

The incremental costs for case studies #0100 and #0101 were developed using calculations from the detailed costing analyses, mainly #0102 and #0103. As part of the EPA work assignment, subsystem compilations were calculated for downsizing, air induction, and fuel induction on the engine. For each of the sixteen (16) engine subsystems, costs for each component were broken out and compiled for contribution to downsizing, adding turbocharging and direct inject. From this data, it was possible to develop relationships between engine configuration and displacement, and the cost impact of downsizing, adding turbocharging and adding direct injection.

Case study #0100 calculates the cost impact of 1.0L I3, 4V, DOHC, d-VVT, TC, GDI engine compared to a conventional 1.4L, I4, 4V, DOHC, d-VVT, NA, PFI engine. The average horsepower for both engines is estimated to be approximately 100hp.

Case study #0101 calculates the cost impact of 1.2L I4, 4V, DOHC, d-VVT, TC, GDI engine compared to a conventional 1.6L, I4, 4V, DOHC, d-VVT, NA, PFI engine. The average horsepower for both engines is estimated to be approximately 121hp.

Table E-1: 1.6L, I4, DS, TC, GDI ICE Compared to 2.4L I4, NA, PFI, ICE Hardware Overview

Item	Characteristics	Baseline Technology Package	New Technology Package
1	Engine Name/Code	ED3 (GEMA Engine)	Prince/N14B16 (Mini Cooper)
2	Engine Type	2.4L DOHC, I4, 16V	1.6L DOHC I4, 16V
3	Displacement (cc)	2360	1598
4	Aspiration	Naturally Aspirated	Turbocharged (Twin Scroll, Wastegate)
5	Compression Ratio	10.5:1	10.5:1
6	Variable Valve Timing	Intake and Exhaust	Intake Only
7	Variable Valve Lift	No	No
8	Multi Displacement System	No	No
9	Variable Intake Manifold	Yes	No
10	Bore (mm)	88	77
11	Stroke (mm)	97	85.9
12	Fuel System	Sequential Electronic Port Fuel Injection	Direct Injection, Side Mounted Solenoid (7 Hole)
13	Block Material	Aluminum	Aluminum
14	Cylinder Head Material	Aluminum	Aluminum
15	Cylinder Liner Material	Cast Iron	Cast Iron
16	Connecting Rod Material	Forged Steel	Forged Steel
17	Intake Manifold Material	Composite	Composite
18	Horse Power @ RPM	173 HP (129kW) @ 6000	172 hp (128kW) @ 5500
19	Torque (lb.ft) @ rpm (normal)	166 lb.-ft. (222Nm) @ 4400	177 lb.-ft. (240Nm) @ 1600-5000
20	Torque (lb.ft) @ rpm (over boost)	N/A	192 lb.-ft. @ 1600-5000 rpm
21	Transmission	CVT, CVT2, 5 Speed Manual	6 Speed Auto or Manual
22	Curb Weight	3310 (Sebring LX -2008)	2668 (Manual)
23	Fuel Economy (City/Highway)	21/30 (Sebring-LX-2008)	29/36 (Manual)
24	Emission Certification	PZEV	Tier 2, Bin 5 / LEV-2
25	Fuel Octane	87	87/91
26	Application(s)	Chrysler Sebring, Dodge Avenger, Caliber R/T & Journey, Jeep Compass & Patriot	Mini Cooper S, Hard Top, Clubman, Convertible
27	Manufacturer	Chrysler (Hyundai & Mitsubishi)	Citroen BMW (Mini)
28	Plant Locations	x2 Dundee Michigan, (x2 South Korea, 1 Shiga Japan)	Birmingham, England
29	Engine Production Volume	Chrysler Projections: 840K (Study Assumption 450K)	20K (Study Assumption 450K)

**POWERTRAIN PACKAGE
PROFORMA**

TECHNOLOGY CONFIGURATION:

Downsized (I4 downsized to a smaller I4), turbocharged, gasoline direct injection (GDI) Engine versus Port-fuel injected, 4-valve, naturally aspirated gasoline engine.

EPA Case Study Number : #0101
ICCT Case Study Number: #0102



Table E-2: 2.0L, I4, DS, TC, GDI ICE Compared to 3.0L V6, NA, PFI ICE Hardware Overview

**POWERTRAIN PACKAGE
PROFORMA**

TECHNOLOGY CONFIGURATION:
 Downsized (V6 downsized to a I4),
 turbocharged, gasoline direct injection (GDI)
 Engine versus Port-fuel injected, 4-valve,
 naturally aspirated gasoline
 engine.

EPA Case Study Number : #0102
 ICCT Case Study Number: #0103



Item	Characteristics	Baseline Technology Package	New Technology Package
1	Engine Name/Code	2008 Ford Duratec ST30	Theoretical engine scaled off Prince/N14B16 (Mini Cooper S Engine)
2	Engine Type	V6, 24 Valve, DOHC	I4, 16V, DOHC
3	Displacement, cc (CID)	3.0L	2.0L
4	Aspiration	Naturally Aspirated	Turbocharged (Twin Scroll, Wastegate)
5	Compression Ratio	9.8:1	10.5:1
6	Variable Valve Timing (VVT)	Hardware: Intake -VVT, Study Assumption: Dual-VVT	Hardware: Intake -VVT, Study Assumption: Dual-VVT
7	Variable Valve Lift	No	No
8	Multi Displacement System	No	No
9	Variable Intake Manifold	Yes	No
10	Bore (mm)	89	85.9 (Scaled 1.6L Mini)
11	Stroke (mm)	79.5	85.9
12	Fuel System	Sequential multi-port electronic injection	Direct Injection, Side Mounted Solenoid (7 Hole), < 150 bar
13	Block Material	Hardware: Aluminum Sand Cast, Study Assumption: Aluminum Diecast	Aluminum Die Cast
14	Cylinder Head Material	Aluminum	Aluminum
15	Cylinder Liner Material	Cast Iron	Cast Iron
16	Connecting Rod Material	PM Steel Forged/Cracked	PM Steel Forged/Cracked
17	Intake Manifold Material	Composite (Aluminum & Glassed Reinforced Nylon)	Glass Reinforced Nylon
18	Horse Power @ RPM	221 (165kW) @ 6250	Est. 225 (168kW) @ 4000/6000 (Scaled 1.6L Mini)
19	Torque (lb-ft) @ rpm (normal)	205 (278Nm) @ 4750	Est. 205 @ (278Nm)) 2000/4000 (Scaled 1.6L Mini)
20	Transmission	Electronic 6-speed automatic with overdrive	Electronic 6-speed automatic with overdrive
21	Fuel Economy (City/Highway)	18/26	NA
22	Emission Certification	Tier 2, Bin 4 / LEV-2 ULEV	Tier 2, Bin 5 / LEV-2 (Based 1.6L Mini)
23	Fuel Octane	Unleaded regular/E85	87/91 (Based on 1.6L Mini)
24	North American Applications	Ford Fusion	n/a
25	Manufacturer	Ford Motor Company	n/a
26	Plant Locations	Mexico	n/a
27	Annual Engine Volume	Actual: Approximately 300K, (Study Assumption 450K)	(Study Assumption 450K)

Table E-3: 3.5L, V6, DS, TC, GDI ICE Compared to 5.4L, V8, NA, PFI ICE Hardware Overview

**POWERTRAIN PACKAGE
PROFORMA**

TECHNOLOGY CONFIGURATION:
 Downsized (V8 downsized to a V6), turbocharged, gasoline direct injection (GDI) Engine versus Port-fuel injected, 3-valve, naturally aspirated gasoline engine.

EPA Case Study Number : #0105
 ICCT Case Study Number: #0106



Item	Characteristics	Baseline Technology Package	New Technology Package
1	Engine Name/Code	Ford Triton / 5.4L 3V NA	Theoretical engine based off Ford EcoBoost / 3.5L GTDI iVCT
2	Engine Type	5.4L 3-valve SOHC V8	3.5L EcoBoost™ 24-valve DOHC V6
3	Displacement, cc (CID)	5,400 cc (330)	3496 cc (213.0)
4	Aspiration	Naturally Aspirated	Twin-Garrett GT15 Turbocharged 12psi
5	Compression Ratio	9.8:1	10.0:1
6	Variable Valve Timing (VVT)	Yes	Actual Hardware: Intake-VVT, Study Assumption: Dual-VVT
7	Variable Valve Lift	No	No
8	Multi Displacement System	No	No
9	Variable Intake Manifold	No	No
10	Bore (mm)	90.17	92.5
11	Stroke (mm)	105.92	88.7
12	Fuel System	Sequential multi-port electronic injection	Direct Injection
13	Block Material	Cast Iron	Aluminum
14	Cylinder Head Material	Aluminum	Aluminum
15	Cylinder Liner Material	Steel	Cast Iron
16	Connecting Rod Material	PM Steel Forged/Cracked	PM Steel Forged/Cracked
17	Intake Manifold Material	Composite	Cast Aluminum (costed as composite)
18	Horse Power @ RPM	300 (224kW) @ 5000 rpm	355 (265kW) @ 5700 rpm
19	Torque (lb-ft) @ rpm (normal)	365 (494Nm) @ 3750 rpm	350 (475Nm) @ 3500 rpm
20	Transmission	Electronic 6-speed manual overdrive	6-speed electronically controlled automatic overdrive with paddle activation
21	Fuel Economy (City/Highway)	4x2 14/20, 4x4 14/18	17/25 (AWD standard equipment)
22	Emission Certification	LEV-2	LEV-2
23	Fuel Octane	Unleaded regular/E85	87/91 Octane (recommended)
24	Application(s)	Ford F-Series Light Duty Truck	Ford Flex and Taurus SHO and Lincoln MKS and MKT
25	Manufacturer	Ford Motor Company	Ford Motor Company
26	Plant Locations	Romeo, MI & Windsor, ONT	Lima Engine Plant, Ohio
27	Annual Engine Volume	Actual: 2008 Approximately 410K, (Study Assumption 450K)	(Study Assumption 450K)

E.1.1.2 Variable Valve Timing and Lift Valvetrain Technology

For the variable valvetrain timing and lift (VVTL) technology configuration cost analysis (Case Study #0200), the Alfa Romeo MiTo 1.4L, I4, Turbo, Port Fuel Injected (PFI), MultiAir ICE (135 hp) was procured. Although the purchased engine came with a turbocharger air induction subsystem, it was excluded from the evaluation. Only components added or modified for the adaptation of the VVTL system were considered in the analysis.

Figure E-1 illustrates the primary hardware associated with the MultiAir system. In the MultiAir I4 ICE application there are two (2) intake and exhaust valves per cylinder, the same as the conventional baseline I4 ICE. The MultiAir system has a single overhead cam (SOHC) that drives both the intake and exhaust valves. The exhaust valves in the MultiAir system are driven by direct contact between the exhaust cam lobes and mechanical buckets. The intake valves are actuated by the MultiAir hydraulic system. The intake cam lobe actuates a hydraulic piston via the finger follower assembly. A solenoid valve controls the hydraulic fluid flow from the hydraulic piston into the hydraulic brake and lash adjuster. When the solenoid is closed, the hydraulic fluid creates a rigid connection between the intake valve and SOHC intake lobe. In this scenario, valve timing and lift follow the intake cam profile, similar to that of a traditional ICE. With the solenoid valves open, hydraulic pressure is minimized in the system, decoupling the intake valves from the camshaft. Through precisely timed solenoid valve opening and closing events, the intake valve lift and timing can be altered.

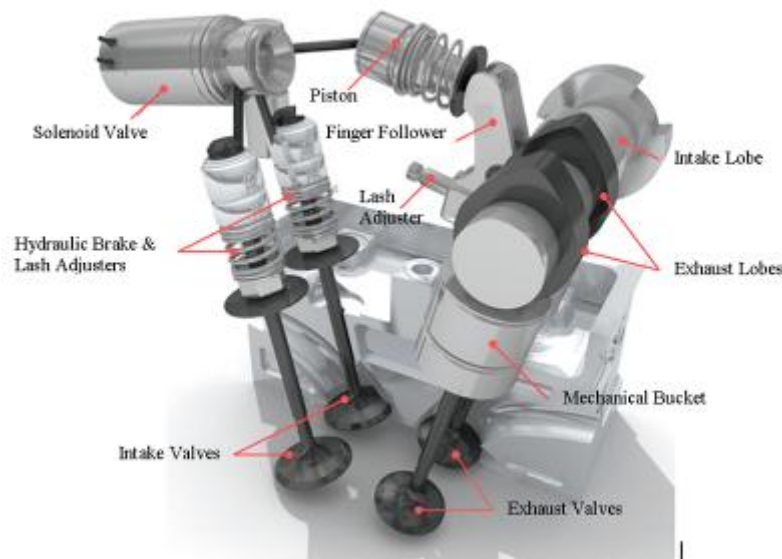

Figure E-1: MultiAir Hardware Illustration

The baseline ICE configuration includes two (2) overhead camshafts, an intake camshaft, and exhaust camshaft. In the baseline configuration, the intake and exhaust camshafts actuate the respective valves through the mechanical bucket valvetrain hardware – similar to the exhaust valvetrain system shown in **Figure E-1**. With the baseline configuration, variable valve timing is accounted for using a cam phaser system. Outside of the changes to the valvetrain, cylinder head, air intake, and electrical/electronic engine subsystems, no other significant engine subsystem changes (e.g., cylinder block, crank drive, cooling, exhaust, fuel, etc.) were required to the baseline engine to add the MultiAir hardware.

Previously completed case studies, such as V6 to I4 downsized, turbocharged gasoline direct injection engine and V8 to V6 downsized, turbocharged gasoline direct injection engine, were used to support the component modification costs to the baseline technology configuration (1.4L I4, NA, PFI, ICE, with dual variable valve timing). Examples of components referenced from these prior case studies include cam phasers and associated hardware, intake and exhaust cam shafts, and conventional valvetrain hardware.

E.1.2 Engine Cost Analysis Overview

In **Table E.4**, the incremental direct manufacturing costs for the five (5) downsized (DS), turbocharge (TC), gasoline direct injection (GDI) case studies evaluated are presented. For the three (3) case studies that involved detailed teardowns, the cost impact per each engine subsystem is shown. As discussed, the results for case studies #0100 and #0101 were developed based on scaling the results at a subsystem compilation level; therefore, the same level of subsystem detail is not broken out for these two case studies. The incremental direct manufacturing costs, based on primary subsystem compilations (e.g., downsizing, turbocharging, and direct injection) are shown in **Table E.5** for all five case studies.

For the advance variable valve timing and lift (VVTL) technology configuration, only the subcompact vehicle segment was evaluated. **Table E.6** shows the cost of adding the MultiAir hardware (Row F.2) to a conventional I4 engine configuration. In addition, other engine subsystem cost debits and credits affected by the adaptation of the MultiAir technology are included.

Table E.7 provides a listing of the Indirect Cost Multipliers (ICMs) and Learning Factors for both the DS, TC, and GDI analyses as well as the VVTL valvetrain analysis. As discussed in **Sections B.6** and **B.7**, the factors applied are derived for each core technology and in some cases required the breaking out of costs at a subsystem compilation level so the appropriate factors could be applied. The factors are provided for production years 2012, 2016, 2020, and 2025. Based on the factors shown in **Table E.7**, the net incremental (direct and indirect) manufacturing costs are calculated and shown in **Table E.8**.

Table E-4: Downsized, Turbocharged, Gasoline Direct Inject ICE Incremental Direct Manufacturing Cost Subsystem Summary

ICCT Europe Analysis: Downsized, Turbocharged, Gasoline Direct Injection Engine Technology Configurations							
System ID	System Description	Calculated Incremental Manufacturing Cost - Downsized, Turbocharged, Gasoline Direct Injection Engines					
		Subcompact Segment, Passenger Seating: 2-4	Compact or Small Segment, Passenger Seating: 2-5	Mid Size Segment, Passenger Seating: 4-5	Mid to Large Size Segment, Passenger Seating: 4-7	Small to Mid Size Sports Utility and Cross Over Segment, Passenger Seating: 4-5	Large Sports Utility Segment, Passenger Seating: 4-7
	Vehicle Example	VW Polo	VW Golf	VW Passat	VW Sharon	VW Touran	VW Touareg
Basic Powertrain Parameters	Typical Engine Size Range (Liters)	1.2-1.4	1.4-1.6	1.6-2.0	2.0-3.0	1.2-3.0	3.0-5.5
	Average Curb Weight (lb)	2390	2803	3299	3749	3505	4867
	Average Power (hp)	100	121	157	234	178	364
	Average Torque (lb·ft)	108	132	174	237	195	362
	Weight-to-Power Ratio (lb/hp)	24	23	21	16	20	13
	Baseline Technology Configuration	1.4L, I4, 4V, DOHC, NA, PFI, dVVT, ICE	1.6L, I4, 4V, DOHC, NA, PFI, dVVT, ICE	2.4L, I4, 4V, DOHC, NA, PFI, dVVT, ICE	3.0L, V6, 4V, DOHC, NA, PFI, dVVT, ICE	Results from case study 0102 or 0103 applicable to vehicle segment - dependent on baseline powertrain size	5.4L, V8, 3V, SOHC, NA, PFI, sVVT, ICE
	New Technology Configuration	1.0L, I3, 4V, DOHC, Turbo, GDI, dVVT, ICE	1.2L, I4, 4V, DOHC, Turbo, GDI, dVVT, ICE	1.6L, I4, 4V, DOHC, Turbo, GDI, dVVT, ICE	2.0L, I4, 4V, DOHC, Turbo, GDI, dVVT, ICE		3.5L, V6, 4V, DOHC, Turbo, GDI, dVVT, ICE
A	Engine Frames, Mounting & Bracket Subsystem	SA ₍₁₎	SA ₍₁₎	€ 0	€ 0	---	€ 0
B	Crank Drive Subsystem	SA ₍₁₎	SA ₍₁₎	€ 1	(€ 25)	---	(€ 19)
C	Counter Balance Subsystem	SA ₍₁₎	SA ₍₁₎	(€ 27)	€ 28	---	€ 0
D	Cylinder Block Subsystem	SA ₍₁₎	SA ₍₁₎	(€ 4)	€ 16	---	€ 32
E	Cylinder Head Subsystem	SA ₍₁₎	SA ₍₁₎	€ 6	(€ 108)	---	(€ 1)
F	Valvetrain Subsystem	SA ₍₁₎	SA ₍₁₎	€ 7	(€ 86)	---	€ 5
G	Timing Drive Subsystem	SA ₍₁₎	SA ₍₁₎	€ 1	(€ 45)	---	(€ 9)
H	Accessory Drive Subsystem	SA ₍₁₎	SA ₍₁₎	€ 0	€ 5	---	€ 8
I	Intake Subsystem	SA ₍₁₎	SA ₍₁₎	(€ 11)	(€ 23)	---	(€ 27)
J	Fuel Subsystem	SA ₍₁₎	SA ₍₁₎	€ 67	€ 59	---	€ 86
K	Exhaust Subsystem	SA ₍₁₎	SA ₍₁₎	€ 26	(€ 22)	---	€ 44
L	Lubrication Subsystem	SA ₍₁₎	SA ₍₁₎	€ 24	(€ 9)	---	€ 74
M	Cooling Subsystem	SA ₍₁₎	SA ₍₁₎	€ 27	€ 29	---	€ 37
N	Induction Air Charging Subsystem	SA ₍₁₎	SA ₍₁₎	€ 193	€ 209	---	€ 331
O	Exhaust Gas Re-Circulation Subsystem- Not Applicable In Analysis	SA ₍₁₎	SA ₍₁₎	€ 0	€ 0	---	€ 0
P	Breather Subsystem	SA ₍₁₎	SA ₍₁₎	€ 3	€ 13	---	€ 24
Q	Engine Management, Engine Electronic and Electrical Subsystems	SA ₍₁₎	SA ₍₁₎	€ 40	€ 26	---	€ 49
R	Accessories Subsystem (Starter Engines, Alternators, Power Steering Pumps, etc)	SA ₍₁₎	SA ₍₁₎	€ 12	€ 12	---	€ 14
Net Incremental Direct Manufacturing Cost		€ 230	€ 360	€ 367	€ 80	---	€ 648

Notes: (1) Results calculated by scaling detailed costs, from surrogate analyses, at subsystem compilation levels (SA = Scaled Analysis)

Table E-5: Downsized, Turbocharged, Gasoline Direct Inject ICE Incremental Direct Manufacturing Cost Summary by Function

ICCT Europe Analysis: Downsized, Turbocharged, Gasoline Direct Injection Engine Technology Configurations							
System ID	System Description	Calculated Incremental Manufacturing Cost - Downsized, Turbocharged, Gasoline Direct Injection Engines					
		Subcompact Segment, Passenger Seating: 2-4	Compact or Small Segment, Passenger Seating: 2-5	Mid Size Segment, Passenger Seating: 4-5	Mid to Large Size Segment, Passenger Seating: 4-7	Small to Mid Size Sports Utility and Cross Over Segment, Passenger Seating: 4-5	Large Sports Utility Segment, Passenger Seating: 4-7
	Vehicle Example	VW Polo	VW Golf	VW Passat	VW Sharon	VW Touran	VW Touareg
Basic Powertrain Parameters	Typical Engine Size Range (Liters)	1.2-1.4	1.4-1.6	1.6-2.0	2.0-3.0	1.2-3.0	3.0-5.5
	Average Curb Weight (lb)	2390	2803	3299	3749	3505	4867
	Average Power (hp)	100	121	157	234	178	364
	Average Torque (lb*ft)	108	132	174	237	195	362
	Weight-to-Power Ratio (lb/hp)	24	23	21	16	20	13
	Baseline Technology Configuration	1.4L, I4, 4V, DOHC, NA, PFI, dVVT, ICE	1.6L, I4, 4V, DOHC, NA, PFI, dVVT, ICE	2.4L, I4, 4V, DOHC, NA, PFI, dVVT, ICE	3.0L, V6, 4V, DOHC, NA, PFI, dVVT, ICE	Results from case study 0102 or 0103 applicable to vehicle segment - dependent on baseline powertrain size	5.4L, V8, 3V, SOHC, NA, PFI, sVVT, ICE
	New Technology Configuration	1.0L, I3, 4V, DOHC, Turbo, GDI, dVVT, ICE	1.2L, I4, 4V, DOHC, Turbo, GDI, dVVT, ICE	1.6L, I4, 4V, DOHC, Turbo, GDI, dVVT, ICE	2.0L, I4, 4V, DOHC, Turbo, GDI, dVVT, ICE		3.5L V6, 4V, DOHC, Turbo, GDI, dVVT, ICE
A	Subsystem Compilation of Direct Injection Cost Impact	€ 132	€ 138	€ 142	€ 147	---	€ 246
B	Subsystem Compilation of Turbocharging Cost Impact	€ 232	€ 237	€ 255	€ 279	---	€ 522
C	Subsystem Compilation of Downsizing Cost Impact	(€ 134)	(€ 15)	(€ 30)	(€ 345)	---	(€ 119)
Net Incremental Direct Manufacturing Cost		€ 230	€ 360	€ 367	€ 80	---	€ 648

Table E-6: Variable Valve Timing and Lift (Fiat MultiAir System), Incremental Direct Manufacturing Cost Subsystem Summary

ICCT Europe Analysis: Variable Valve Timing and Lift Technology Configuration (Fiat Multi-Air System)								
System ID	System Description	Calculated Incremental Manufacturing Cost - Downsized, Turbocharged, Gasoline Direct Injection Engines						
		Subcompact Segment, Passenger Seating: 2-4	Compact or Small Segment, Passenger Seating: 2-5	Mid Size Segment, Passenger Seating: 4-5	Mid to Large Size Segment, Passenger Seating: 4-7	Small to Mid Size Sports Utility and Cross Over Segment, Passenger Seating: 4-5	Large Sports Utility Segment, Passenger Seating: 4-7	
	Vehicle Example	VW Polo	VW Golf	VW Passat	VW Sharon	VW Touran	VW Touareg	
Basic Powertrain Parameters	Typical Engine Size Range (Liters)	1.2-1.4	1.4-1.6	1.6-2.0	2.0-3.0	1.2-3.0	3.0-5.5	
	Average Curb Weight (lb)	2390	2803	3299	3749	3505	4867	
	Average Power (hp)	100	121	157	234	178	364	
	Average Torque (lb*ft)	108	132	174	237	195	362	
	Weight-to-Power Ratio (lb/hp)	24	23	21	16	20	13	
	Baseline Technology Configuration	1.4L, I4, 4V, DOHC, NA, PFI, dVVT, ICE	--	--	--	--	--	--
	New Technology Configuration	1.4L, I4, 4V-MultiAir, SOHC, NA, PFI, ICE	--	--	--	--	--	--
E	Cylinder Head Subsystem	(€ 11)	---	---	---	---	---	
F	Valvetrain Subsystem	€ 118	---	---	---	---	---	
F.1	Baseline Engine Valvetrain Credits	(€ 53)	---	---	---	---	---	
F.2	Multi-Air Hardware Additions	€ 171	---	---	---	---	---	
G	Timing Drive Subsystem	(€ 3)	---	---	---	---	---	
I	Intake Subsystem	(€ 7)	---	---	---	---	---	
Q	Engine Management, Engine Electronic and Electrical Subsystems	€ 10	---	---	---	---	---	
Net Incremental Direct Manufacturing Cost		€ 107	---	---	---	---	---	

Table E-7: Application of Indirect Cost Multipliers and Learning Curve Factors to Evaluated Engine Technologies (DS, TC, GDI ICE & VVTL)

Technology ID	Case Study #	Baseline Technology Configuration	New Technology Configuration	Calculated Incremental Direct Manufacturing Cost 2010/2011 Production Year	ICM and Learning Factor Categorization			ICM Factor				Learning Factor			
					Description	Percent Contribution	Calculated Values	ICM-Warranty		ICM-Other Indirect Costs		2012	2016	2020	2025
								Short Term	Long Term	Short Term	Long Term				
								2012 thru 2018	2019 thru 2025	2012 thru 2018	2019 thru 2025				
ENGINES	1 0100	1.4L, I4, 4V, DOHC, NA, PFI, dVVT, ICE	1.0L, I3, 4V, DOHC, Turbo, GDI, dVVT, ICE	€ 230	GDI	57%	€ 132	0.045	0.031	0.343	0.259	1.00	0.89	0.82	0.74
					TC	101%	€ 232	0.045	0.031	0.343	0.259	1.00	0.89	0.82	0.74
					DS	-58%	(€ 134)	0.045	0.031	0.343	0.259	1.00	1.00	1.00	1.00
					Totals	100%	€ 230								
	2 0101	1.6L, I4, 4V, DOHC, NA, PFI, dVVT, ICE	1.2L, I4, 4V, DOHC, Turbo, GDI, dVVT, ICE	€ 360	GDI	38%	€ 138	0.045	0.031	0.343	0.259	1.00	0.89	0.82	0.74
					TC	66%	€ 237	0.045	0.031	0.343	0.259	1.00	0.89	0.82	0.74
					DS	-4%	(€ 15)	0.045	0.031	0.343	0.259	1.00	1.00	1.00	1.00
					Totals	100%	€ 360								
	3 0102	2.4L, I4, 4V, DOHC, NA, PFI, dVVT, ICE	1.6L, I4, 4V, DOHC, Turbo, GDI, dVVT, ICE	€ 367	GDI	39%	€ 142	0.045	0.031	0.343	0.259	1.00	0.89	0.82	0.74
					TC	69%	€ 255	0.045	0.031	0.343	0.259	1.00	0.89	0.82	0.74
					DS	-8%	(€ 30)	0.045	0.031	0.343	0.259	1.00	1.00	1.00	1.00
					Totals	100%	€ 367								
	4 0103	3.0L, V6, 4V, DOHC, NA, PFI, dVVT, ICE	2.0L, I4, 4V, DOHC, Turbo, GDI, dVVT, ICE	€ 80	GDI	183%	€ 147	0.045	0.031	0.343	0.259	1.00	0.89	0.82	0.74
					TC	347%	€ 279	0.045	0.031	0.343	0.259	1.00	0.89	0.82	0.74
					DS	-430%	(€ 345)	0.045	0.031	0.343	0.259	1.00	1.00	1.00	1.00
					Totals	100%	€ 80								
	5 0106	5.4L, V8, 3V, SOHC, NA, PFI, sVVT, ICE	3.5L V6, 4V, DOHC, Turbo, GDI, dVVT, ICE	€ 648	GDI	38%	€ 246	0.045	0.031	0.343	0.259	1.00	0.89	0.82	0.74
					TC	80%	€ 522	0.045	0.031	0.343	0.259	1.00	0.89	0.82	0.74
					DS	-18%	(€ 119)	0.045	0.031	0.343	0.259	1.00	1.00	1.00	1.00
					Totals	100%	€ 648								
	6 0200	1.4L, I4, 4V, DOHC, NA, PFI, dVVT, ICE	1.4L, I4, 4V-MultiAir, SOHC, NA, PFI, ICE	€ 107	n/a	n/a	n/a	0.045	0.031	0.343	0.259	1.10	0.97	0.89	0.81

Table E-8: Net Incremental (Direct + Indirect) Manufacturing Costs for Evaluated Engine Technologies (DS, TC, GDI ICE & VVTL)

Technology ID	Case Study #	Baseline Technology Configuration	New Technology Configuration	Calculated Incremental Direct Manufacturing Cost 2010/2011 Production Year	ICM and Learning Factor Categorization			Net Incremental Manufacturing Costs (Direct + Indirect Costs) with Applicable Learning Applied			
					Description	Percent Contribution	Calculated Values	2012	2016	2020	2025
ENGINES	1 0100	1.4L, I4, 4V, DOHC, NA, PFI, dVVT, ICE	1.0L, I3, 4V, DOHC, Turbo, GDI, dVVT, ICE	€ 230	GDI	57%	€ 132	€ 183	€ 168	€ 146	€ 135
					TC	101%	€ 232	€ 321	€ 293	€ 255	€ 236
					DS	-58%	(€ 134)	(€ 82)	(€ 82)	(€ 95)	(€ 95)
					Totals	100%	€ 230	€ 423	€ 379	€ 305	€ 276
	2 0101	1.6L, I4, 4V, DOHC, NA, PFI, dVVT, ICE	1.2L, I4, 4V, DOHC, Turbo, GDI, dVVT, ICE	€ 360	GDI	38%	€ 138	€ 192	€ 175	€ 152	€ 141
					TC	66%	€ 237	€ 328	€ 300	€ 261	€ 241
					DS	-4%	(€ 15)	(€ 9)	(€ 9)	(€ 11)	(€ 11)
					Totals	100%	€ 360	€ 511	€ 466	€ 402	€ 372
	3 0102	2.4L, I4, 4V, DOHC, NA, PFI, dVVT, ICE	1.6L, I4, 4V, DOHC, Turbo, GDI, dVVT, ICE	€ 367	GDI	39%	€ 142	€ 196	€ 179	€ 156	€ 144
					TC	69%	€ 255	€ 354	€ 323	€ 280	€ 260
					DS	-8%	(€ 30)	(€ 18)	(€ 18)	(€ 21)	(€ 21)
					Totals	100%	€ 367	€ 532	€ 484	€ 415	€ 383
	4 0103	3.0L, V6, 4V, DOHC, NA, PFI, dVVT, ICE	2.0L, I4, 4V, DOHC, Turbo, GDI, dVVT, ICE	€ 80	GDI	183%	€ 147	€ 204	€ 186	€ 162	€ 150
					TC	347%	€ 279	€ 386	€ 353	€ 307	€ 284
					DS	-430%	(€ 345)	(€ 211)	(€ 211)	(€ 245)	(€ 245)
					Totals	100%	€ 80	€ 379	€ 328	€ 223	€ 189
	5 0106	5.4L, V8, 3V, SOHC, NA, PFI, sVVT, ICE	3.5L V6, 4V, DOHC, Turbo, GDI, dVVT, ICE	€ 648	GDI	38%	€ 246	€ 341	€ 312	€ 271	€ 251
					TC	80%	€ 522	€ 724	€ 661	€ 574	€ 532
					DS	-18%	(€ 119)	(€ 73)	(€ 73)	(€ 85)	(€ 85)
					Totals	100%	€ 648	€ 992	€ 900	€ 760	€ 698
	6 0200	1.4L, I4, 4V, DOHC, NA, PFI, dVVT, ICE	1.4L, I4, 4V-MultiAir, SOHC, NA, PFI, ICE	€ 107	n/a	n/a	n/a	€ 159	€ 145	€ 126	€ 117

E.2 Transmission Technology Configurations Evaluated

E.2.1 Transmission Technology Overview

Three (3) transmission technology configurations were evaluated as part of this work scope: (1) 6-speed compared to a 5-speed automatic transmission; (2) 6-speed dual clutch transmission compared to a 6-speed automatic transmission; and (3) 8-speed automatic compared to a 6-speed automatic transmission. Details for each technology configuration are summarized below. All three transmission technologies were initially evaluated as part of the EPA work assignment.

E.2.1.1 6-Speed Automatic Compared to 5-Speed Automatic Transmission

Case Study #0803 analyzed the direct incremental manufacturing cost for updating from a conventional 5-speed automatic transmission to a next generation 6-speed automatic transmission.

The 5-speed automatic transmission selected for the analysis was the Toyota U151E FWD transmission. This transmission was used in various applications, including the Toyota Camry, through the 2005-2006 timeframe. The main construction of the transmission includes three (3) full planetary gear sets. The front and rear planetary gear sets are positioned in series along a common intermediate shaft assembly. Adjacent to the front and rear planetary sets, and mounted in series to the counter shaft assembly, is a third underdrive planetary set. The transmission contains a total of nine (9) shift elements, four (4) disc clutches, three (3) disc brakes, and two (2) one-way clutches. The hydraulic valve body assembly, containing a total of seven (7) shift solenoid valves is controlled directly by the engine control module (ECM). The total weight of the transmission, including Automatic Transmission Fluid (ATF), is approximately 221 lbs. The maximum output torque rating for the U151E is 258 lb.-ft.

The 6-speed automatic transmission selected for the analysis was the replacement transmission to the Toyota 5-speed. The Toyota 6-speed FWD transmission (U660E) was a complete redesign of the existing U151E transmission, which launched in the 2007 timeframe. Employing a Ravigneaux and underdrive planetary gear set, positioned along a common intermediate shaft assembly, the U660E gear driveline is much simpler compared to its predecessor. Only six (6) shift elements are required for operation of the transmission; two (2) disc clutches, three (3) disc brakes, and one (1) one-way-clutch. The U660E valve body assembly also contains a total of seven (7) shift solenoid valves interfacing with an exterior-mount transmission control module (TCM), which in turn communicates with the engine control module (ECM). The total weight of the transmission, including ATF, is 208 lbs. The maximum output torque rating for the U660E is 295 lb.-ft. Additional details for both transmission cover in **Table E.9**.

Table E-9: 6-Speed AT Compared to 5-Speed AT, Hardware Overview

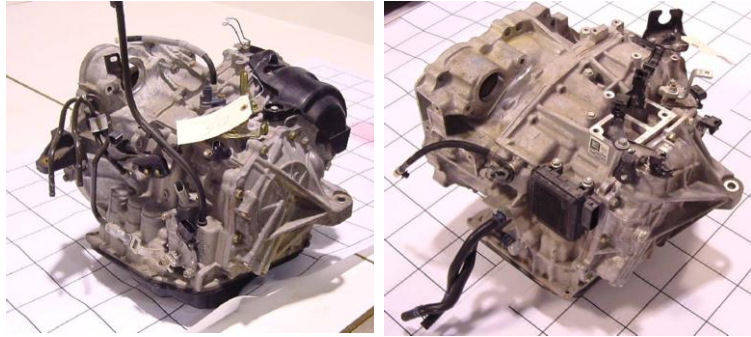
Item	Characteristics	Baseline Technology Package	New Technology Package
<div style="display: flex; justify-content: space-between; align-items: flex-start;"> <div style="border: 2px solid black; padding: 5px; width: 30%; background-color: #f0f0f0;"> <p style="text-align: center; color: red; margin: 0;">POWERTRAIN PACKAGE PROFORMA</p> <p>TECHNOLOGY CONFIGURATION: 5-Speed Automatic Transmission compared to an equivalent 6-Speed Automatic Transmission</p> <p>EPA Case Study Number : #0802 ICCT Case Study Number: #0803</p> </div> <div style="width: 65%; text-align: center;">  </div> </div>			
1	Transmission Name / Code	2004/2007 Toyota 5-Speed Automatic Transmission, U151E	2007-Present, Toyota 6-Speed Automatic Transmission, U660E
2	Transmission Type	5-Speed Automatic Transmission for FWD Mid to Large Size Passenger Vehicles	6-Speed Automatic Transmission for FWD Mid to Large Size Passenger Vehicles
3	Control System	Electric-Hydraulic	Electric-Hydraulic
4	Geartrain	3 Planetary Sets: Front, Rear and Underdrive	One Ravigneaux Planetary and One Underdrive Planetary
5	Internal Clutches	4 Disc Clutches, 3 Disc Brakes, and 2 Sprags all Electro-Hydraulically Controlled.	2 Disc Clutches, 3 Disc Brakes, and 1 Sprag all Electro-Hydraulically Controlled.
6	Launch Clutch Subsystem	Electro-Hydraulically Controlled Torque Converter with Lock-up Clutch	Electro-Hydraulically Controlled Torque Converter with Lock-up Clutch
7	Engine Connection	Flex Plate Assembly	Flex Plate Assembly
8	Gear Ratios	(Ratio Data Published per SAE 2002-01-0936)	(Ratio Data Published per SAE 2006-01-0847)
	First	4.235	3.300
	Second	2.360	1.900
	Third	1.517	1.420
	Fourth	1.047	1.000
	Fifth	0.756	0.713
	Sixth	n/a	0.608
	Reverse	3.378	4.148
	Final I	n/a	n/a
	Final II	n/a	n/a
9	Maximum Torque Capacity	258 lb-ft	295 lb-ft
10	Approximate Weight (with Automatic Transmission Fluid)	221 lbs	208 lbs
11	North American Application(s)	Camry, Solara, Sienna, Avalon, Lexus RX330	Camry, Lexus ES-350, Avalon
12	Annual Case Study Volume Assumption:	(Study Assumption 450K)	(Study Assumption 450K)

E.2.1.2 6-Speed Dual Clutch Transmission Compared to a 6-Speed Automatic Transmission

Case Study #0903 analyzed the direct incremental manufacturing cost for updating from a conventional 6-speed automatic transmission to a 6-speed, wet, dual clutch transmission.

The baseline technology configuration selected for the analysis was the Toyota 6-speed automatic transmission (U660E) of case study #0803. General design parameters of the U660E transmission can be found in **Section E.2.1.2**.

The new technology configuration selected for the analysis was the Volkswagen (VW) 6-speed, wet, dual clutch transmission (DCT); model number DQ250. Other industry naming conventions for this technology configuration include twin-clutch gearbox or dual shift gearbox (DSG). The basic components of the DCT include a twin clutch pack assembly driving two (2) coaxial input shafts. Power from the engine is transmitted to the input shafts through a dual-mass flywheel which is connected in series to the twin-clutch pack. Each input shaft, dependent on the selected gear, is designed to mesh with one (1) of two (2) output shafts. Upon reverse gear selection, there is an intermediate shaft which engages with both input shaft one (1) and output shaft two (2). There are four (4) shift forks, two (2) on each output shaft, hydraulically activated into one of two positions from their neutral home position. The controls for the DCT, which include the hydraulic controls, electronic controls, and various sensors and actuators, are integrated into a single module VW refers to as a Mechatronic unit. The total weight of the transmission module, including the dual-mass flywheel, is approximately 207 lbs. The maximum output torque rating for the DQ250 transmission is 258 lb.-ft.

Table E-10: 6-Speed DSG/DCT Compared to 6-Speed AT, Hardware Overview

**POWERTRAIN PACKAGE
 PROFORMA**

TECHNOLOGY CONFIGURATION:
 6-Speed Wet Dual Clutch Transmission
 compared to an equivalent 6-Speed
 Automatic Transmission

EPA Case Study Number : #0902
 ICCT Case Study Number: #0903



Item	Characteristics	Baseline Technology Package	New Technology Package
1	Transmission Name / Code	2007-Present, Toyota 6-Speed Automatic Transmission, U660E	Volkswagen Direct Shift Gearbox (DSG)/Dual Clutch Transmission, DQ250
2	Transmission Type	6-Speed Automatic Transmission for FWD Mid to Large Size Passenger Vehicles	6-Speed, Twin Wet Clutch Transmission for FWD Mid Size Passenger Vehicles
3	Control System	Electric-Hydraulic	Electric-Hydraulic
4	Geartrain	One Ravigneaux Planetary and One Underdrive Planetary	Two Coaxial Input Gear Shaft Assemblies, Two Output Gear Shaft Assemblies, and a Intermediate Gear Shaft Assembly for Reverse Gear.
5	Internal Clutches	2 Disc Clutches, 3 Disc Brakes, and 1 Sprag all Electro-Hydraulically Controlled	Four Electro-Hydraulically Controlled Shift Fork and Synchronizer Gear Assemblies
6	Launch Clutch Subsystem	Electro-Hydraulically Controlled Torque Converter with Lock-up Clutch	Two Electro-Hydraulically Controlled, Oil-Cooled Multi-Plate Clutches
7	Engine Connection	Flex Plate Assembly	Dual-mass Flywheel assembly
8	Gear Ratio	(Ratio Data Published per SAE 2006-01-0847)	(Calculated Ratios)
	First	3.300	3.36
	Second	1.900	2.09
	Third	1.420	1.47
	Fourth	1.000	1.10
	Fifth	0.713	1.09
	Sixth	0.608	0.92
	Reverse	4.148	3.99
	Final I	n/a	3.94
	Final II	n/a	3.14
9	Maximum Torque Capacity	295 lb-ft	258 lb-ft
10	Approximate Weight (with Transmission Fluid)	208 lbs	207 lbs
11	North American Application(s)	Camry, Lexus ES-350, Avalon	Jetta Sports Wagon
12	Annual Case Study Volume Assumption:	(Study Assumption 450K)	(Study Assumption 450K)

E.2.1.3 8-Speed Automatic Transmission compared to a 6-Speed Automatic Transmission

Case Study #1006 analyzed the direct incremental manufacturing cost for updating from a ZF 6-speed, Lepelletier concept, automatic transmission to a next generation 8-speed automatic transmission.

The 6-speed automatic transmission selected for the baseline analysis was the ZF 6HP28 RWD transmission (second generation of ZF 6HP26). This transmission is/has been used in various applications, including the BMW Series 3 Coupe and the X5 SUV in the 2007-2012 timeframe. The ZF 6-Speed transmission incorporates a Lepelletier AT gearing configuration, which utilizes a single planetary gear set along with a Ravigneaux gear set. The use of a Lepelletier configuration allowed ZF to add an additional gear without sacrificing size, weight and part content over the existing 5-speed AT. In fact, the 6-speed AT weighs approximately 12% less, and has 29% fewer parts, than its predecessor. The 6-speed AT contains a total of five (5) shift elements, three (3) clutches, and two (2) brakes. There are two (2) open shift elements per gear. The total weight of the transmission, including Automatic Transmission Fluid (ATF), is approximately 203lbs. The maximum output torque rating is 479lb.*ft.

The ZF 8-speed automatic transmission (AT), the successor to the ZF 6-speed AT, was selected for the analysis representing the new advance technology configuration. The ZF 8-speed RWD transmission (8HP70) (Figure 2-2) was a complete redesign of the existing Lepelletier-based 6-speed transmission family, which originally launched in the 2001 timeframe. The implementation of a revolutionary gearing system, consisting of four (4) planetary gear sets, controlled by an equivalent number of shift elements (i.e., three [3] clutches and two [2] brakes) as compared to the ZF 6-speed AT, supports a net 6% overall fuel economy improvement relative to its predecessor. In addition to maintaining the same overall installation dimensions, the new 8-speed transmission has a higher torque to weight ratio. The 8-speed AT weighs in at approximately 196lbs. (including ATF) providing a maximum output torque rating of 516lb.*ft. Additional details on both transmissions can be found following in **Table E.11**.

Table E-11: 8-Speed AT Compared to 6-Speed AT, Hardware Overview

POWERTRAIN PACKAGE PROFORMA

TECHNOLOGY CONFIGURATION:
6-Speed ZF Automatic Transmission compared to an equivalent 8-Speed ZF Automatic Transmission

EPA Case Study Number : #1005
ICCT Case Study Number: #1006

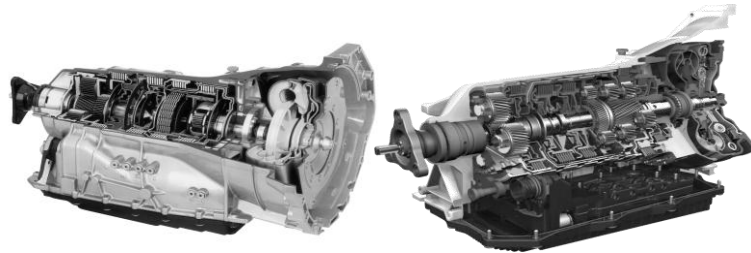

Item	Characteristics	Baseline Technology Package	New Technology Package
1	Transmission Name / Code	ZF 6HP28 RWD	ZF 8HP70 RWD
2	Transmission Type	6-Speed Automatic Transmission for FWD Mid to Large Size Passenger Vehicles	8-Speed Automatic Transmission for FWD Mid to Large Size Passenger Vehicles
3	Control System	Electric-Hydraulic (TCU)	Electric-Hydraulic
4	Geartrain	1 Planetary Set and a Ravigneaux gear set:	4 Planetary Gear sets
5	Internal Clutches	3 Disc Clutches, 2 Disc Brakes, and 2 Sprags all Electro-Hydraulically Controlled.	3 Disc Clutches, 2 Disc Brakes, and 1 Sprag all Electro-Hydraulically Controlled.
6	Launch Clutch Subsystem	Electro-Hydraulically controlled torque converter lock-up on all six forward gears, and disengage completely when at a standstill	Electro-Hydraulically Controlled Torque Converter with Lock-up Clutch
7	Engine Connection	Flex Plate Assembly	Flex Plate Assembly
8	Gear Ratios	(Ratio Data Published per SAE 2002-01-0936)	(Ratio Data Published per SAE 2006-01-0847)
	First	4.170	4.696
	Second	2.340	3.130
	Third	1.520	2.104
	Fourth	1.140	1.667
	Fifth	0.870	1.285
	Sixth	0.690	1.000
	Seventh	n/a	0.839
	Eighth	n/a	0.667
	Reverse	3.400	3.300
	Final I	2.810	2.810
	Final II	n/a	n/a
9	Maximum Torque Capacity	479 lb-ft	516 lb-ft
10	Approximate Weight (with Automatic Transmission Fluid)	203 lbs	196 lbs
11	North American Application's)	BMW Series 3 Coupe and X5 SUV	BMW Series 7, Chrysler 300 and Dodge Charger
12	Annual Case Study Volume Assumption:	(Study Assumption 450K)	(Study Assumption 450K)

E.2.2 Transmission Cost Analysis Overview

In **Table E.12** the incremental direct manufacturing costs for the three (3) transmission evaluations are shown. For each transmission technology configuration evaluated a single vehicle segment was considered for each with no scaling performed to alternative vehicle segments. As shown in the table, both the 6-speed AT compared to the 5-speed AT, and the 6-speed DCT compared to the 6-speed AT, represent a negative cost impact. That is, there is a saving recognized in changing to the advance technology configuration under the defined boundary conditions.

In the 6-speed AT to 5-speed AT, the reconfiguration of the transmission using the Ravigneaux gear set configuration allowed Toyota to reduce component count and costs. Conceivably, these same changes could have been made to the 5-speed AT making the incremental direct manufacturing cost between the 5-speed and 6-speed a wash (i.e., cost neutral) at a minimum.

For the 6-speed DCT comparison to the 6-speed AT, significant savings of the DCT hardware over the AT hardware was evident in the internal clutch subsystem, geartrain subsystem and case subsystem. Conversely, the launch clutch subsystem, which included the twin clutch assembly and dual mass fly wheel, was a cost hit over the baseline 6-speed AT.

The ZF 8-speed AT was calculated to cost approximately €43 more relative to the ZF 6-speed AT transmission (2010/2011 incremental direct manufacturing cost). From **Table E.12**, it is evident the majority of the costs are associated with the geartrain subsystem as the new 8-speed transmission has four (4) planetary sets compared to its predecessor, which utilized a single planetary gear set and a Ravigneaux gear set. The majority of the other subsystems were cost neutral between the two transmissions.

Table E.13 provides a listing of the Indirect Cost Multipliers (ICMs) and Learning Factors for all three transmission configurations analyzed. Similar to the engines analyses, the factors are provided for production years 2012, 2016, 2020, and 2025. Based on the factors shown in **Table E.13**, the net incremental (direct and indirect) manufacturing costs are calculated and shown in **Table E.14**.

Table E-12: Transmission Technology Configurations, Incremental Direct Manufacturing Cost Subsystem Summary

ICCT Europe Analysis: Advance Transmission Technology Configurations				
System ID	System Description	Calculated Incremental Manufacturing Cost - Advance Transmission Technology Configurations		
		Mid to Large Size Segment, Passenger Seating: 4-7	Mid to Large Size Segment, Passenger Seating: 4-7	Large Sports Utility Segment, Passenger Seating: 4-7
	Vehicle Example	VW Sharon	VW Sharon	VW Touareg
Basic Powertrain Parameters	Typical Engine Size Range (Liters)	2.0-3.0	2.0-3.0	3.0-5.5
	Average Curb Weight (lb)	3749	3749	4867
	Average Power (hp)	234	234	364
	Average Torque (lb*ft)	237	237	362
	Weight-to-Power Ratio (lb/hp)	16	16	13
	Baseline Technology Configuration	5-Speed Automatic Transmission	6-Speed Automatic Transmission	6-Speed Automatic Transmission
	New Technology Configuration	6-Speed Automatic Transmission	6-Speed Wet Dual Clutch Transmission	8-Speed Automatic Transmission
A	External Component Subsystem	€ 0	€ 0	€ 0
B	Case Subsystem	(€ 4)	(€ 34)	€ 0
C	Geartrain Subsystem	(€ 22)	(€ 31)	€ 49
D	Internal Clutch Subsystem	(€ 52)	(€ 87)	(€ 7)
E	Launch Clutch Subsystem	€ 0	€ 43	€ 0
F	Oil Pump and Filter Subsystem	€ 0	€ 0	€ 0
G	Mechanical Controls Subsystem	(€ 1)	(€ 9)	€ 0
H	Electrical Controls Subsystem	€ 0	(€ 2)	€ 0
I	Park Mechanism Subsystem	€ 0	(€ 0)	€ 0
J	Miscellaneous	€ 0	€ 0	€ 0
Net Incremental Direct Manufacturing Cost		(€ 79)	(€ 121)	€ 43

Table E-13: Application of Indirect Cost Multipliers and Learning Curve Factors to Evaluated Transmission Technologies (6-Speed AT, 8-Speed AT, 6-Speed DCT)

Technology ID	Case Study #	Baseline Technology Configuration	New Technology Configuration	Calculated Incremental <i>Direct</i> Manufacturing Cost 2010/2011 Production Year	ICM and Learning Factor Categorization			ICM Factor				Learning Factor				
					Description	Percent Contribution	Calculated Values	ICM-Warranty		ICM-Other Indirect Costs		2012	2016	2020	2025	
								Short Term 2012 thru 2018	Long Term 2019 thru 2025	Short Term 2012 thru 2018	Long Term 2019 thru 2025					
TRANSMISSIONS	1	0802	5-Speed AT	6-Speed AT	(€ 79)	n/a	n/a	n/a	0.012	0.005	0.230	0.187	1.00	1.00	1.00	1.00
	2	0803	6-Speed AT	8-Speed AT	€ 43	n/a	n/a	n/a	0.045	0.031	0.343	0.259	1.00	0.89	0.82	0.74
	3	0902	6-Speed AT	6-Speed Wet DCT	(€ 121)	n/a	n/a	n/a	0.045	0.031	0.343	0.259	1.00	1.00	1.00	1.00

Table E-14: Net Incremental (Direct + Indirect) Manufacturing Costs for Evaluated Transmission Technologies (6-Speed AT, 8-Speed AT, 6-Speed DCT)

Technology ID	Case Study #	Baseline Technology Configuration	New Technology Configuration	Calculated Incremental <i>Direct</i> Manufacturing Cost 2010/2011 Production Year	ICM and Learning Factor Categorization			Net Incremental Manufacturing Costs (<i>Direct + Indirect Costs</i>) with Applicable Learning Applied				
					Description	Percent Contribution	Calculated Values	2012	2016	2020	2025	
TRANSMISSIONS	1	0802	5-Speed AT	6-Speed AT	(€ 79)	n/a	n/a	n/a	(€ 60)	(€ 60)	(€ 63)	(€ 63)
	2	0803	6-Speed AT	8-Speed AT	€ 43	n/a	n/a	n/a	€ 59	€ 54	€ 47	€ 44
	3	0902	6-Speed AT	6-Speed Wet DCT	(€ 121)	n/a	n/a	n/a	(€ 74)	(€ 74)	(€ 86)	(€ 86)

E.3 Start-Stop HEV Technology Configuration Evaluated

E.3.1 Start-Stop HEV Technology Overview

For the BAS cost analysis, the 2007 Saturn Vue Green Line vehicle was selected. At the time of the analysis it was one of the few production-available start/stop hybrids in the marketplace. Based on the team's initial assessment of the BAS technology, in particular the adaptation/integration of the BAS components into baseline vehicle configuration, a decision was made to only teardown the Saturn Vue Green Line vehicle. The team felt any changes made to baseline conventional vehicle could readily be identified in the advance vehicle hardware (i.e., Green Line Vehicle) without having the baseline vehicle hardware present for reference. In questionable cases, published service documentation was used to support the team's assumptions on the differences between the two technology configurations. In general, the design team for the Saturn Vue did a good job adding the BAS hardware with minimal disruption to the existing baseline vehicle. A great approach for a low annual volume production build vehicle sharing a common platform. Although one could argue that this low-level integration of the new BAS components with the existing conventional components favors a conservative cost estimate for BAS systems at high volume.

In the BAS HEV cost analysis, both the Saturn Vue baseline (i.e., conventional vehicle) and new technology configuration (i.e., Green Line/BAS vehicle) utilized the same family engine and transmission. The internal combustion engine is GM's 2.4L Ecotec engine (≈ 170 hp). The transmission is a small, mid-size car front-wheel-drive, 4-speed automatic transmission. Modifications were required to both the engine and transmission in order to adopt the BAS system technology to the baseline Saturn Vue. The main engine hardware changes include the replacement of the standard alternator with a 14.5 kW starter motor/generator, which provides engine restart, launch assist, and regenerative braking added functionality. To support the advanced starter motor/generator, a dual tensioner assembly replaced the standard baseline tensioner. The major modification on the transmission consisted of an externally mounted transmission pump required to maintain system pressure on ICE shut down.

A 36V, 18.4Ah, prismatic nickel metal hydride battery provides the necessary power to the starter motor/generator. The battery is packaged behind the rear passenger seat (**Figure E-2**). Packaged under the hood, toward the front of the vehicle on the passenger side, is the starter generator control module (SGCM)/power electronic controls center. The SGCM is connected to the vehicle's 12V (conventional service battery) and 36V DC circuits. A high-voltage wire harness extends from the 36V battery pack to the SGCM via a high-voltage wire harness packaged and protected on the underside of the vehicle. Three (3)-phase high-voltage AC cables also run between the SGCM and the starter motor/generator.



(Source: <http://revocars.com/190/2007-saturn-vue-green-line-hybrid-suv>)

Figure E-2: Saturn Vue Green Line Primary BAS Technology Configuration

In addition to the high-voltage connections mentioned, the SGCM also controls items such as the transmission auxiliary pump, brake hill hold solenoids, auxiliary heater core pump, and SGCM auxiliary cooling pump.

Smaller design changes, with much less impact on the direct manufacturing costs, were also made in the brake system and body-in-white system.

E.3.2 Start-Stop HEV Cost Analysis Overview

Table E-15 provides the system/subsystem incremental direct manufacturing cost impact for adding start-stop HEV technology to a midsize passenger vehicle. As shown in the table, the Electrical Power Supply system and Power Distribution and Controls system are responsible for approximately 86% of the costs for adding the start-stop technology. The high-voltage traction battery, within the Electrical Power Supply System, represents 49% of the added vehicle costs. The incremental direct manufacturing cost of the Belt Start Alternator (BAS) is relatively low (\approx €36) since its cost is offset by the conventional vehicle alternator.

The power electric center, within the Power Distribution and Controls system, represents 28% of the added vehicle costs. The high-voltage wire harness, and other electric distribution associated hardware, contributes an additional 6% to the overall vehicle cost.

The third-largest overall cost contributor associated with adding the start-stop HEV technology was the engine system. The cooling subsystem additions (e.g., auxiliary coolant pump, tubes hoses) and accessory drive subsystem modifications (e.g., belt, tensioner, bracket assembly) contributed nearly 7% of the total vehicle incremental direct manufacturing costs.

Table E.16 provides a listing of the Indirect Cost Multipliers (ICMs) and Learning Factors for the start-stop HEV technology analyzed. Based on the factors shown in **Table E.16**, the net incremental (direct and indirect) manufacturing costs are calculated and shown in **Table E.17**.

Table E-15: Start-Stop HEV (BAS), Incremental Direct Manufacturing Cost System-Subsystem Summary

ICCT Europe Analysis: Start-Stop Vehicle HEV Technology Configuration (Belt Alternator Starter System with Brake Regeneration and Launch Assist)		
System ID	System Description	Calculated Incremental Manufacturing Cost - Start-Stop Vehicle Technology Configuration
		Mid Size Segment, Passenger Seating: 4-5
	Vehicle Example	VW Passat
Basic Powertrain Parameters	Curb Weight Average "lb" (% Mass Reduction)	3299.00
	ICE Power "kW" (hp)	125 (170)
	Starter Motor - Generator Power "kW" (hp)	14.5 (19.4)
	High Voltage Battery Capacity "V, kWh"	36, 0.662
	Baseline Technology Configuration	Conventional Powertrain >I4 Gasoline ICE, 4V, DOHC, NA, PFI, VVT >4-Speed AT
	New Technology Configuration	Belt Alternator Starter (BAS) - HEV (Brake Regen & Launch Assist) >I4 Gasoline ICE, 4V, DOHC, NA, PFI, VVT >4-Speed AT >Electric Generator/Starter 14.5kW >Battery: 36V, 18.4Ah NiMH
A	Engine System	€ 85
B	Transmission System	€ 39
C	Body System	€ 10
D	Brake System	€ 31
E	Electrical Power Supply System	€ 613
E.1	>Start Motor-Generator Subsystem	€ 36
E.2	>High Voltage Traction Battery Subsystem	€ 576
F	Power Distribution and Controls System	€ 398
F.1	>Electrical Wiring and Circuit Protection Subsystem	€ 16
F.2	> Traction And High Voltage Power Distribution Subsystem	€ 67
F.3	> Power Electric Center (PEC) Subsystem	€ 315
	Net Incremental Direct Manufacturing Cost	€ 1,176

Table E-16: Application of Indirect Cost Multipliers and Learning Curve Factors to Start-Stop HEV (BAS)

Technology ID	Case Study #	Baseline Technology Configuration	New Technology Configuration	Calculated Incremental <u>Direct</u> Manufacturing Cost 2010/2011 Production Year	ICM and Learning Factor Categorization			ICM Factor				Learning Factor			
					Description	Percent Contribution	Calculated Values	ICM-Warranty		ICM-Other Indirect		2012	2016	2020	2025
								Short Term 2012 thru 2018	Long Term 2019 thru 2025	Short Term 2012 thru 2018	Long Term 2019 thru 2025				
Start-Stop HEV	1 0402	Conventional Powertrain >I4 Gasoline ICE, 4V, DOHC, NA, PFI, VVT >4-Speed AT	Belt Alternator Starter (BAS) - HEV (Brake Regen & Launch Assist) >I4 Gasoline ICE, 4V, DOHC, NA, PFI, VVT >4-Speed AT >Electric Generator/Starter 14.5kW >Battery: 36V, 18.4Ah NIMH	€ 1,176	n/a	n/a	n/a	0.045	0.031	0.343	0.259	1.56	1.00	0.89	0.76

Table E-17: Net Incremental (Direct + Indirect) Manufacturing Cost for Evaluated Start-Stop HEV (BAS)

Technology ID	Case Study #	Baseline Technology Configuration	New Technology Configuration	Calculated Incremental <u>Direct</u> Manufacturing Cost 2010/2011 Production Year	ICM and Learning Factor Categorization			Net Incremental Manufacturing Costs (Direct + Indirect Costs) with Applicable Learning Applied			
					Description	Percent Contribution	Calculated Values	2012	2016	2020	2025
Start-Stop HEV	1 0402	Conventional Powertrain >I4 Gasoline ICE, 4V, DOHC, NA, PFI, VVT >4-Speed AT	Belt Alternator Starter (BAS) - HEV (Brake Regen & Launch Assist) >I4 Gasoline ICE, 4V, DOHC, NA, PFI, VVT >4-Speed AT >Electric Generator/Starter 14.5kW >Battery: 36V, 18.4Ah NIMH	€ 1,176	n/a	n/a	n/a	€ 2,323	€ 1,632	€ 1,378	€ 1,226

E.4 Power-Split HEV Technology Configuration Evaluated

E.4.1 Power-Split HEV Technology Overview

The 2010 Ford Fusion power-split HEV was the lead power-split HEV case study evaluated using the detailed teardown and costing methodology. From this initial analysis, scaling models were developed to calculate the incremental direct manufacturing costs for the same power-split technology configuration applied to alternative vehicle segments: In **Section 4.1.1** the Ford Fusion technology is discussed; **Section 4.1.2** provides an overview of the boundary assumption differences between the EPA U.S. analysis and the ICCT Europe analysis; and **Section 4.1.3** provides an overview of the power-split scaling methodology.

E.4.1.1 Ford Fusion Power-Split HEV Technology Overview

The 2010 Fusion Hybrid and 2010 Fusion SE were chosen for the power-split analysis. Because both vehicles share a common platform, made on the same assembly line (Hermosillo, Mexico), they provide a very effective means of analyzing the cost impact when advanced propulsion technology is integrated throughout a vehicle platform.

Both vehicles are comparably equipped four-door sedans. The Fusion SE has a conventional front-wheel drive layout with a 3.0 liter V6 internal combustion engine (ICE) coupled to a 6-speed automatic transaxle.

The Fusion Hybrid's powertrain retained a front-wheel drive layout, but coupled a 2.5 liter inline 4-cylinder Atkinson ICE with an electronic continuous variable transmission (eCVT). The eCVT module contains both an electric traction motor and generator coupled to the ICE through a single planetary gear set. The Motor Control Unit (MCU), Generator Control Unit (GCU), and Transmission Control Unit (TCU), as well as other required high-power electronic components, are all contained within the eCVT. To keep the primary components (e.g., power electronics, control electronics, motors/generator, gearing) of the eCVT within an acceptable operating temperature, a separate cooling circuit consisting primarily of an electrically operated coolant pump and heat exchanger were added to the HEV vehicle over the baseline.

The high-voltage power supply for the electric motor and generator consists of a 275V, 5.5 Ampere-Hour (Ah) nickel metal hydride (NiMH) traction battery and dedicated HV electrical harness. The battery module is positioned between the C-pillars of the vehicle directly behind the rear passenger seat. To keep the battery temperature within a safe and functional operating temperature, a forced air cooling system was integrated into the battery module. Modifications to the rear seat were required to support the flow of cooler air from the passenger cabin through the battery module, exhausting the heated air into the rear truck compartment.

The Fusion HEV retained a 12-volt system to operate all non-hybrid vehicle systems. However a DC-DC converter replaced the alternator for charging the 12-volt battery.

In addition to the primary system changes (e.g., engine, transmission, power supply and power distribution) required for the adaptation of power-split HEV technology, changes to less “technology critical” systems were also made, such as the change from a mechanical driven AC compressor to an electrical-driven compressor and the addition of an auxiliary electric-coolant pump. Both are examples of climate control system components requiring modifications to accommodate ICE shutdown.

As a further means to improve the regenerative brake capture percentage, Ford also elected to launch their new power-split HEV technology with a brake-by-wire system. The adaptation of brake-by-wire technology over the conventional braking system resulted in a series of changes to brake actuation, power brake, and brake controls subsystems.

These various vehicle systems discussed, which were modified either as a direct or indirect result of the adaptation of HEV power-split technology, were all included in the analysis since all had some level of cost impact over the baseline vehicle. It should be noted that component differences existed in other systems (e.g., suspension, frame and mounting, driveline, electrical feature) between the Fusion SE (baseline) and Fusion Hybrid (power-split HEV). Many of these differences were related to component placement, component tuning, or feature addition differences between the two vehicles. Upon team review, many of the differences were determined to be insignificant from a cost perspective, as the component differences were estimated to have minor impact, there were offsetting component costs within the systems, or the component/technology addition was not a mandatory requirement driven by the adaptation of power-split HEV technology.

An illustration of the HEV power-split basic concept can be found in **Figure E-3**. **Table E-18** provides a list of selected vehicle attributes for comparison between the baseline technology configuration (Ford Fusion SE) and the new technology configuration (Ford Fusion HEV).

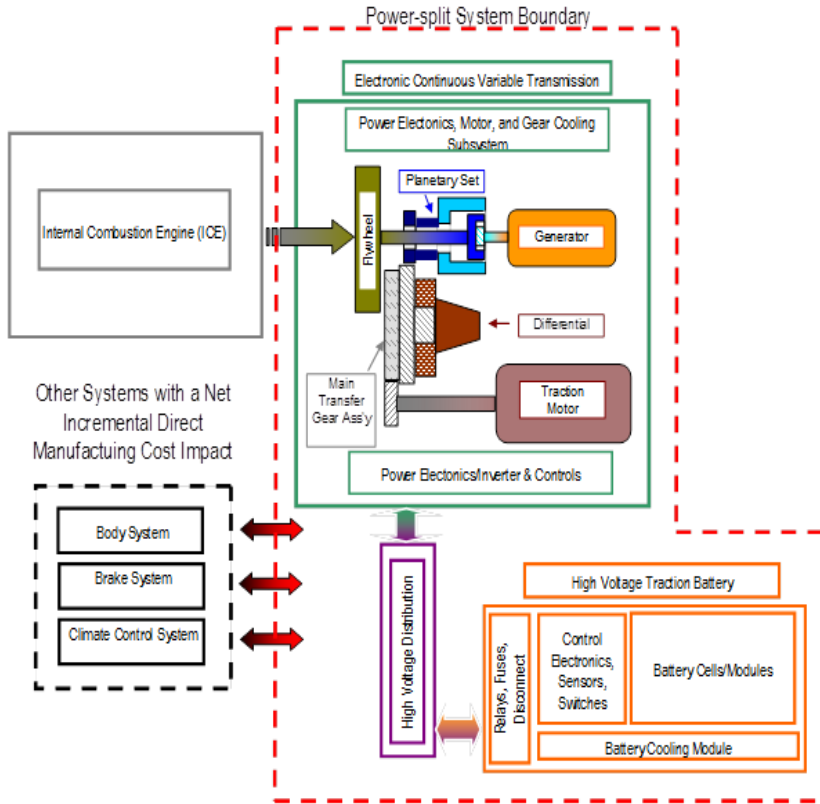

Figure E-3: Power-Split System Boundary Illustration

Table E-18: Power-Split HEV (2010 Ford Fusion) Compared to Conventional Powertrain Vehicle, Hardware Overview

**POWERTRAIN PACKAGE
PROFORMA**

TECHNOLOGY CONFIGURATION:
 Power-Split Hybrid Electric Vehicle with a I4 Internal Combustion Engine (ICE) and Electronic Continuous Variable Transmission compared to a Conventional Powertrain Vehicle with a V6 ICE and 6-Speed Automatic Transmission

EPA Case Study Number : #0502
 ICCT Case Study Number : #0502



Item	Characteristics	Baseline Technology Package	New Technology Package
1	Vehicle Year/Make/Model	2010 Ford Fusion SE	2010 Ford Fusion Hybrid
2	Manufacturer	Ford	Ford
3	Curb Weight (lbs.)	3,446	3,720
4	Wheelbase (in.)	107.4	107.4
5	Length (in.)	190.6	190.6
6	Width (w/o mirrors) (in.)	72.2	72.2
7	Height (in.)	56.8	56.8
8	Coefficient of Drag	0.32	0.32
9	Tire Size	225 / 50R17 93V	225 / 50R17 93V
10	Drive Layout	Front Wheel Drive	Front Wheel Drive
11	Engine Configuration	Front Engine, Transverse Mount	Front Engine, Transverse Mount
12	Powertrain Type	Internal Combustion Engine (ICE)	Hybrid Electric Vehicle (HEV) (ICE + Electric Motors)
13	Hybrid Layout	N/A	Power-Split
14	Engine Type	3.0L V6 DOHC 24V VVT PFI	2.5L I-4 DOHC 16V VVT PFI
15	Engine Cycle	Otto Cycle	Atkinson Cycle
16	Aspiration	Naturally Aspirated	Naturally Aspirated
17	Compression Ratio	10.3:1	12.3:1
18	Redline (rpm)	6,600	6,550
19	Engine Power (hp) @ rpm	240 hp (179 kW) @ 6,550 rpm	156 hp (116 kW) @ 6,500 rpm
20	Engine Torque (lb-ft) @ rpm	223 ft-lb (302 N-m) @ 4,300 rpm	136 ft-lb (184 N-m) @ 2,250 rpm
21	Power to Weight Ratio (lbs. / hp)	14.4	19.5
22	Specific Output (hp / liter)	80.0	62.4
23	Engine Block Material	Cast Aluminum	Cast Aluminum
24	Cylinder Head Material	Cast Aluminum	Cast Aluminum
25	Transmission Type	6-speed Automatic Transaxle (6F35)	Electronic Continuous Variable Transmission (eCVT)
26	0-60 Time (sec.)	7.3	8.7
27	Quarter Mile Time (sec.) @ mph	15.3 @ 91.8 mph*	16.4 @ 87.8 mph**
28	Fuel Octane	Unleaded regular/E85	Unleaded regular/E85
29	Fuel Capacity (U.S. gal.)	17.5	17.5
30	Fuel Economy (City/Highway)	18 / 27	41 / 36
31	Estimated Range City/Hwy	367 / 262 miles	663 miles
32	Emission Certification	Tier 2 Bin 4 / LEV-II ULEV	Tier 2 Bin 3 / LEV-II SULEV
33	Number of Powertrain Electric Motors	0	2
34	Electric Motor Type	N/A	AC Synchronous Permanent Magnet
35	Electric Motor Power (combined)	N/A	106 hp (79 kW) @ 6,500 rpm
36	Electric Motor Torque (combined)	N/A	166 ft-lb (225 N-m) @ 3,000 rpm
37	Battery Type	N/A	Nickel Metal Hydride (NiMH)
38	Battery Pack Size	N/A	208 D-Cell Type Batteries
39	Battery Pack Voltage	N/A	275 V
40	Nominal Battery Pack Capacity	N/A	5.5 A-hr, 1.51 kW-hr
41	Net Power	N/A	191 hp (142 kW) @ 6,000 rpm
42	HVAC Setup	Belt-driven A/C Compressor	Electronically Driven A/C Compressor
43	Cooling Setup	Belt-driven Water Pump	Aux. Coolant Pump (in addition to belt-driven water pump)
44	Braking Setup	Hydraulic Brakes	Brake-by-Wire (in addition to hydraulic system)
45	Vehicle Production Volume***	250k Reference Only (Study Assumption 450K)	25-50k Reference Only (Study Assumption 450K)

E.4.1.2 Power-Split Assumption Differences for ICCT versus EPA Analysis

In the EPA Ford Fusion power-split analysis, the production stock, high-voltage traction motor NiMH battery was evaluated. No assumption changes were made from the physical hardware present in the vehicle. In addition, all power-split, scaled vehicle segment derivatives also assumed a NiMH high voltage traction motor battery.

Conversely, all power-split ICCT European analyses assumed lithium-ion, high-voltage traction motor batteries in place of the NiMH battery. The change in assumptions to a lithium-ion battery for the power-split applications provided an improved means of comparison to the P2 HEVs analyses which also assumed lithium-ion batteries.

To support the development of lithium-ion battery costs, the battery packaged in the 2010 Hyundai Avante, sold domestically in South Korea, was evaluated. The analysis provided a good comparison of the manufacturing costs between the NiMH and lithium-ion battery as well as some of the physical attributes of the batteries, namely size and weight.

The Ford Fusion production stock NiMH battery is a larger capacity battery (275 V, 5.5Ah, 1.51kWh, 26 modules approximately, 10.6 volts/module) in comparison to the Hyundai Avante lithium-ion battery (180V, 5.3Ah, 0.954kWh, six [6] modules, thirty [30] volts/module). Not accounting for the state of charge (SOC) swing differences between the NiMH and lithium-ion batteries, a size and weight comparison was made by scaling the lithium-ion battery pack up to an nearly equivalent NiMH size by adding three (3) additional modules (30 Volts/Module x 9 = 270 Volts). In summary the scaled lithium-ion battery weighed 46% less and was only 80% the volume of the NiMH battery.

For calculating the power-split and P2 battery power capacities, a capacity/pound vehicle mass value was utilized ($1132.5\text{W}\cdot\text{h}/4100\text{ lbs.} = 0.27622\text{W}\cdot\text{h}/\text{lb.}$). This value was developed and utilized in the EPA studies. The vehicle mass used in the calculation (4100 lbs.) was the summation of the curb weight plus 300 lbs. (equivalent to the EPA Emissions Test Weight specification). The corresponding lithium battery capacity assumption for the vehicle was $1.1325\text{kW}\cdot\text{h}$. Since the same method was used to calculate battery capacities in both the power-split and P2 analyses, the battery costs for the power-splits and P2 were near identical for common vehicle segments.

E.4.1.3 Scaling of Ford Fusion Results to European Case Studies

To determine the net incremental direct manufacturing cost for adding power-split powertrain technology to other vehicle segments, a scaling methodology, utilizing the Ford Fusion cost analysis as the foundation, was employed. The scaling process is detailed in **Section B.3.1.3**. A summary of the process is captured below.

The first step in the process involved defining the size of the primary powertrain system components (e.g., internal combustion engine [ICE], traction motor, generator motor, high voltage battery) for the defined vehicle segment. This was accomplished by utilizing

ratios developed within the Ford Fusion analysis (i.e., ICE/traction motor horsepower ratio, battery sizing to traction/generator motor sizing, etc.), and applying them to the new vehicle segment to establish primary HEV base component sizes (**Tables G.1, G.2, and G.3**). Note: For the ICCT analysis there was no reduction in power or torque for the hybrid application relative to baseline powertrain.

Once the primary base components were established, component costs within each subsystem/system were developed using manufacturing cost-to-component-size ratios for both the primary base components (e.g., traction motor, high voltage traction battery) and selected vehicle segment attributes (e.g., vehicle footprint, passenger volume, curb weight). The scaled totals for each system were then added together to create an estimated vehicle cost.

E.4.2 Power-Split HEV Cost Analysis Overview

Table E-19 provides the power-split incremental direct manufacturing costs for the five (5) vehicle segments evaluated. The cost impact of the adding the power-split technology is broken out on a vehicle system level basis. In the table header, for each vehicle segment, key powertrain attributes are captured (e.g., curb weight, system power, ICE power, traction motor power, generator power, and battery voltage and capacity).

Table E-20 provides further detail on the incremental direct manufacturing cost contributors by breaking out the key systems cost contributors into subsystem and sub-subsystem (e.g., components, assemblies, modules) costs.

Table E.21 provides a listing of the Indirect Cost Multipliers (ICMs) and Learning factors for the power-split HEV technology and vehicle segments evaluated. As shown in the table, the same ICM factors applied to both battery and non-battery components; although, for the Learning factors different values are used for battery and non-battery component costs. Based on the factors shown in **Table E.21**, the net incremental (direct and indirect) manufacturing costs are calculated and shown in **Table E.22** for production years 2012, 2016, 2020, and 2025.

Table E-19: Power-Split Technology Configuration Incremental Direct Manufacturing Costs System Summary

ICCT Europe Analysis Power-Split HEV Technnology Configuration						
System ID	System Description	Calculated Incremental Manufacturing Cost - Power-Split HEV Technology				
		Subcompact Segment, Passenger Seating: 2-4	Compact or Small Segment, Passenger Seating: 2-5	Mid Size Segment, Passenger Seating: 4-5	Mid to Large Size Segment, Passenger Seating: 4-7	Small to Mid Size Sports Utility and Cross Over Segement, Passenger Seating: 4-5
	Vehicle Example	VW Polo	VW Golf	VW Passat	VW Sharon	VW Touran
Basic Powertrain Parameters	Curb Weight Average "lb" (% Mass Reduction)	2390 (0%)	2803 (0%)	3299 (0%)	3749 (0%)	3513 (0%)
	System Power "kW" (hp) (100% Conventioanl Powertrain)	74.7 (100.2)	90 (120.7)	117 (156.9)	174.8 (234.4)	132.6 (177.7)
	ICE Power "kW" (hp) (81.7% System Power)	61.1 (81.8)	73.6 (98.6)	95.6 (128.1)	142.8 (191.4)	108.3 (145.2)
	Traction Motor Power "kW" (hp) (66.9% System Power)	50 (67)	60.2 (80.7)	78.3 (104.9)	116.9 (156.7)	88.7 (118.8)
	Generator Power "kW" (hp) (46.9% System Power)	35.1 (47.0)	42.3 (56.7)	55 (73.7)	82.1 (110)	62.2 (83.4)
	High Voltage Battery Capacity (V, kW*h)	140, 0.743	162, 0.857	188, 0.994	211, 1.118	199, 1.053
A	Internal Combustion Engine (ICE) System	(€ 136)	(€ 62)	(€ 61)	(€ 384)	(€ 61)
B	Transmission (e-CVT) System	€ 671	€ 711	€ 790	€ 993	€ 841
C	Body System	€ 6	€ 6	€ 6	€ 6	€ 5
D	Brake System	€ 165	€ 168	€ 172	€ 176	€ 174
E	Steering System	n/a	n/a	n/a	n/a	n/a
F	Climate Control System	€ 138	€ 144	€ 151	€ 156	€ 160
G	Electric Power Supply System	€ 816	€ 893	€ 1,017	€ 1,109	€ 1,063
H	Power Distribution and Control System	€ 148	€ 152	€ 155	€ 159	€ 154
	Net Incremental Direct Manufacturing Cost	€ 1,809	€ 2,012	€ 2,230	€ 2,215	€ 2,336

Table E-20: Power-Split Technology Configuration, Incremental Direct Manufacturing Costs, and System/Subsystem Summary

ICCT Europe Analysis Power-Split HEV Technnology Configuration						
System ID	System Description	Calculated Incremental Manufacturing Cost - Power-Split HEV Technology				
		Subcompact Segment, Passenger Seating: 2-4	Compact or Small Segment, Passenger Seating: 2-5	Mid Size Segment, Passenger Seating: 4-5	Mid to Large Size Segment, Passenger Seating: 4-7	Small to Mid Size Sports Utility and Cross Over Segment, Passenger Seating: 4-5
	Vehicle Example	VW Polo	VW Golf	VW Passat	VW Sharon	VW Touran
Basic Powertrain Parameters	Curb Weight Average "lb" (% Mass Reduction)	2390 (0%)	2803 (0%)	3299 (0%)	3749 (0%)	3513 (0%)
	System Power "kW" (hp) (100% Conventioanl Powertrain)	74.7 (100.2)	90 (120.7)	117 (156.9)	174.8 (234.4)	132.6 (177.7)
	ICE Power "kW" (hp) (81.7% System Power)	61.1 (81.8)	73.6 (98.6)	95.6 (128.1)	142.8 (191.4)	108.3 (145.2)
	Traction Motor Power "kW" (hp) (66.9% System Power)	50 (67)	60.2 (80.7)	78.3 (104.9)	116.9 (156.7)	88.7 (118.8)
	Generator Power "kW" (hp) (46.9% System Power)	35.1 (47.0)	42.3 (56.7)	55 (73.7)	82.1 (110)	62.2 (83.4)
	High Voltage Battery Capacity (V, kW*h)	140, 0.743	162, 0.857	188, 0.994	211, 1.118	199, 1.053
A	Internal Combustion Engine (ICE) System	(€ 136)	(€ 62)	(€ 61)	(€ 384)	(€ 61)
B	Transmission (e-CVT) System	€ 671	€ 711	€ 790	€ 993	€ 841
B.1	Case Subsystem	€ 137	€ 146	€ 160	€ 177	€ 166
B.2	Gear Train Subsystem	€ 86	€ 91	€ 99	€ 108	€ 102
B.3	Launch Clutch Subsystem	€ 33	€ 35	€ 39	€ 43	€ 40
B.4	Oil Pump and Filter Subsystem	€ 6	€ 6	€ 7	€ 8	€ 7
B.5	Electric Motor & Controls Subsystem	€ 914	€ 974	€ 1,084	€ 1,317	€ 1,147
B.5.1	Traction and Generator Motors	€ 271	€ 306	€ 370	€ 506	€ 407
B.5.2	Power Electronic Components and Assemblies (Large Standalone Passive Components)	€ 113	€ 121	€ 135	€ 166	€ 143
B.5.3	Control Modules (Motor Control Unit, Generator Control Unit, Transmission Control Unit)	€ 351	€ 363	€ 384	€ 429	€ 396
B.5.4	Traction and Generator Motor Sensors	€ 57	€ 57	€ 57	€ 57	€ 57
B.5.5	Internal Electrical Connections (e.g.wire harness, terminals, bus bars)	€ 66	€ 66	€ 66	€ 66	€ 66
B.5.6	Switches	€ 2	€ 2	€ 2	€ 2	€ 2
B.5.7	Electrical Housings/Support Structure	€ 49	€ 55	€ 65	€ 87	€ 71
B.5.8	Brackets	€ 3	€ 3	€ 3	€ 3	€ 3
B.5.9	Sealing Elements	€ 2	€ 2	€ 2	€ 2	€ 2
B.6	Transmission Cooling System	€ 35	€ 39	€ 48	€ 65	€ 52
B.7	OE Transmission Assembly (brokeout for eCVT only, included in subsystem roll-ups in base analysis)	€ 81	€ 81	€ 81	€ 81	€ 81
B.8	Transmission - Baseline (Credit)	(€ 619)	(€ 663)	(€ 726)	(€ 806)	(€ 755)

(Table E-20 Continued)

System ID	System Description	Calculated Incremental Manufacturing Cost - Power-Split HEV Technology				
		Subcompact Segment, Passenger Seating: 2-4	Compact or Small Segment, Passenger Seating: 2-5	Mid Size Segment, Passenger Seating: 4-5	Mid to Large Size Segment, Passenger Seating: 4-7	Small to Mid Size Sports Utility and Cross Over Segment, Passenger Seating: 4-5
	Vehicle Example	VW Polo	VW Golf	VW Passat	VW Sharon	VW Touran
Basic Powertrain Parameters	Curb Weight Average "lb" (% Mass Reduction)	2390 (0%)	2803 (0%)	3299 (0%)	3749 (0%)	3513 (0%)
	System Power "kW" (hp) (100% Conventioanl Powertrain)	74.7 (100.2)	90 (120.7)	117 (156.9)	174.8 (234.4)	132.6 (177.7)
	ICE Power "kW" (hp) (81.7% System Power)	61.1 (81.8)	73.6 (98.6)	95.6 (128.1)	142.8 (191.4)	108.3 (145.2)
	Traction Motor Power "kW" (hp) (66.9% System Power)	50 (67)	60.2 (80.7)	78.3 (104.9)	116.9 (156.7)	88.7 (118.8)
	Generator Power "kW" (hp) (46.9% System Power)	35.1 (47.0)	42.3 (56.7)	55 (73.7)	82.1 (110)	62.2 (83.4)
	High Voltage Battery Capacity (V, kW*h)	140, 0.743	162, 0.857	188, 0.994	211, 1.118	199, 1.053
C	Body System	€ 6	€ 6	€ 6	€ 6	€ 5
D	Brake System	€ 165	€ 168	€ 172	€ 176	€ 174
E	Steering System	n/a	n/a	n/a	n/a	n/a
F	Climate Control System	€ 138	€ 144	€ 151	€ 156	€ 160
F.1	>Electric AC Compressor Subsystem	€ 108	€ 113	€ 118	€ 122	€ 125
F.2	> Auxiliary Heating Subsystem	€ 30	€ 32	€ 33	€ 34	€ 35
G	Electric Power Supply System	€ 816	€ 893	€ 1,017	€ 1,109	€ 1,063
G.1	Service Battery Subsystem	(€ 3)	(€ 3)	(€ 3)	(€ 3)	(€ 3)
G.2	Generator/Alternator and Regulator Subsystem	(€ 57)	(€ 61)	(€ 79)	(€ 83)	(€ 83)
G.3	<i>High Voltage Traction Battery Subsystem (Li-Ion)</i>	€ 790	€ 864	€ 982	€ 1,070	€ 1,025
G.3.1	Assembly of Battery	€ 14	€ 0	€ 15	€ 16	€ 15
G.3.2	Battery Cells & Cell Modules	€ 449	€ 520	€ 603	€ 674	€ 638
G.3.3	Relays/Fuses/Disconnects	€ 124	€ 124	€ 124	€ 124	€ 124
G.3.4	Internal Wire Harness Connections	€ 21	€ 22	€ 23	€ 24	€ 23
G.3.5	Battery Sensing and Control Modules	€ 133	€ 144	€ 157	€ 168	€ 163
G.3.6	Battery Cooling Module Hardware	€ 19	€ 22	€ 25	€ 28	€ 27
G.3.7	Misc Components (e.g. Brackets, Housings, Covers)	€ 4	€ 5	€ 5	€ 6	€ 6
G.3.8	Vehicle Interfaces (e.g. Brackets, Wiring, etc)	€ 26	€ 27	€ 29	€ 30	€ 28
G.4	Voltage Inverters/Converters Subsystem	€ 85	€ 93	€ 116	€ 124	€ 124
H	Power Distribution and Control System	€ 148	€ 152	€ 155	€ 159	€ 154
	Net Incremental Direct Manufacturing Cost	€ 1,809	€ 2,012	€ 2,230	€ 2,215	€ 2,336

Table E-21: Application of Indirect Cost Multipliers and Learning Curve Factors to Power-Split HEVs

Technology ID	Case Study #	Baseline Technology Configuration	New Technology Configuration	Calculated Incremental Direct Manufacturing Cost 2010/2011 Production Year	ICM and Learning Factor Categorization			ICM Factor				Learning Factor			
					Description	Percent Contribution	Calculated Values	ICM-Warranty		ICM-Other Indirect Costs		2012	2016	2020	2025
								Short Term	Long Term	Short Term	Long Term				
								2012 thru 2018	2019 thru 2025	2012 thru 2018	2019 thru 2025				
Power-Split HEV	1	0500	Subcompact car typically powered by an inline 4 cylinder engine, naturally aspirated, port fuel injection, 5-speed manual transmission (MT). Power-split HEV System Power: 74.7kW ICE Power: 61.1kW (I4 -> I3) Traction Motor: 50kW Generator: 35.1kW Li-Ion Battery: 140V, 0.743kWh	€ 1,809	Batt.	44%	€ 790	0.065	0.032	0.499	0.314	3.05	1.95	1.25	1.00
					Non Batt.	56%	€ 1,018	0.065	0.032	0.499	0.314	1.00	0.89	0.82	0.74
					Totals	100%	€ 1,809								
	2	0501	Compact or small car typically powered by an inline 4 cylinder engine, naturally aspirated, port fuel injection, 6-speed manual transmission or 7-speed dual clutch transmission (DCT). Power-split HEV System Power: 90kW ICE Power: 73.6kW (I4 - DS I4) Traction Motor: 60.2kW Generator: 42.3kW Li-Ion Battery: 162V, 0.857kWh	€ 2,012	Batt.	43%	€ 864	0.065	0.032	0.499	0.314	3.05	1.95	1.25	1.00
					Non Batt.	57%	€ 1,148	0.065	0.032	0.499	0.314	1.00	0.89	0.82	0.74
					Totals	100%	€ 2,012								
3	0502	A midsize passenger car typically powered by a 4 cylinder turbocharged, direct fuel injection, 6-speed MT and AT or 7-speed DCT, Start/Stop system. Power-split HEV System Power: 117kW ICE Power: 95.6kW (I4 -> DS I4) Traction Motor: 78.3kW Generator: 55kW Li-Ion Battery: 188V, 0.994kWh	€ 2,230	Batt.	44%	€ 982	0.065	0.032	0.499	0.314	3.05	1.95	1.25	1.00	
				Non Batt.	56%	€ 1,248	0.065	0.032	0.499	0.314	1.00	0.89	0.82	0.74	
				Totals	100%	€ 2,230									
4	5403	A midsize or large passenger car typically powered by 4 and 6 cylinder turbocharged, direct fuel injection, 6-speed MT or ≥ 6 speed AT. Power-split HEV System Power: 174.8kW ICE Power: 142.8kW (V6 -> I4) Traction Motor: 116.9kW Generator: 82.1kW Li-Ion Battery: 211V, 1.118kWh	€ 2,215	Batt.	48%	€ 1,070	0.065	0.032	0.499	0.314	3.05	1.95	1.25	1.00	
				Non Batt.	52%	€ 1,145	0.065	0.032	0.499	0.314	1.00	0.89	0.82	0.74	
				Totals	100%	€ 2,215									
5	0505	A small or mid-sized sports-utility or cross-over vehicle, or a small-midsize SUV, or a Mini Van powered by a 4 cylinder turbocharged engine, direct fuel injection, 6-speed MT or AT & 7 DCT. Power-split HEV System Power: 132.6kW ICE Power: 108.3kW (I4 -> DS I4) Traction Motor: 88.7kW Generator: 62.2kW Li-Ion Battery: 199V, 1.053 kWh	€ 2,336	Batt.	44%	€ 1,025	0.065	0.032	0.499	0.314	3.05	1.95	1.25	1.00	
				Non Batt.	56%	€ 1,311	0.065	0.032	0.499	0.314	1.00	0.89	0.82	0.74	
				Totals	100%	€ 2,336									
6	---	Large sports-utility vehicles, typically powered by a 8 cylinder naturally aspirated engine, direct fuel injection, ≥ 6-speed AT.	n/a	n/a	Batt.	0%	n/a	0.065	0.032	0.499	0.314	3.05	1.95	1.25	1.00
					Non Batt.	0%	n/a	0.065	0.032	0.499	0.314	1.00	0.89	0.82	0.74
					Totals	0%	€ 0								

Notes: (1) Short Term Period for Power-split and P2 Battery 2012 thru 2024
 (2) Long Term Period for Power-split and P2 Battery 2025+

Table E-22: Net Incremental (Direct + Indirect) Manufacturing Cost for Evaluated Power-Split HEVs

Technology	ID	Case Study #	Baseline Technology Configuration	New Technology Configuration	Calculated Incremental <i>Direct</i> Manufacturing Cost 2010/2011 Production Year	ICM and Learning Factor Categorization			Net Incremental Manufacturing Costs (<i>Direct + Indirect Costs</i>) with Applicable Learning Applied			
						Description	Percent Contribution	Calculated Values	2012	2016	2020	2025
Power-Split HEV	1	0500	Subcompact car typically powered by an inline 4 cylinder engine, naturally aspirated, port fuel injection, 5-speed manual transmission (MT).	Power-split HEV System Power: 74.7kW ICE Power: 61.1kW (I4 -> I3) Traction Motor: 50kW Generator: 35.1kW Li-Ion Battery: 140V, 0.743kWh	€ 1,809	Batt.	44%	€ 790	€ 2,962	€ 2,038	€ 1,446	€ 1,063
						Non Batt.	56%	€ 1,018	€ 1,592	€ 1,468	€ 1,177	€ 1,095
						Totals	100%	€ 1,809	€ 4,555	€ 3,506	€ 2,624	€ 2,158
	2	0501	Compact or small car typically powered by an inline 4 cylinder engine, naturally aspirated, port fuel injection, 6-speed manual transmission or 7-speed dual clutch transmission (DCT).	Power-split HEV System Power: 90kW ICE Power: 73.6kW (I4 - DS I4) Traction Motor: 60.2kW Generator: 42.3kW Li-Ion Battery: 162V, 0.857kWh	€ 2,012	Batt.	43%	€ 864	€ 3,239	€ 2,228	€ 1,581	€ 1,163
						Non Batt.	57%	€ 1,148	€ 1,794	€ 1,654	€ 1,327	€ 1,234
						Totals	100%	€ 2,012	€ 5,034	€ 3,883	€ 2,908	€ 2,397
	3	0502	A midsize passenger car typically powered by a 4 cylinder turbocharged, direct fuel injection, 6-speed MT and AT or 7-speed DCT, Start/Stop system.	Power-split HEV System Power: 117kW ICE Power: 95.6kW (I4 -> DS I4) Traction Motor: 78.3kW Generator: 55kW Li-Ion Battery: 188V, 0.994kWh	€ 2,230	Batt.	44%	€ 982	€ 3,680	€ 2,532	€ 1,797	€ 1,321
						Non Batt.	56%	€ 1,248	€ 1,952	€ 1,799	€ 1,443	€ 1,342
						Totals	100%	€ 2,230	€ 5,632	€ 4,331	€ 3,240	€ 2,663
	4	5403	A midsize or large passenger car typically powered by 4 and 6 cylinder turbocharged, direct fuel injection, 6-speed MT or ≥ 6 speed AT.	Power-split HEV System Power: 174.8kW ICE Power: 142.8kW (V6 -> I4) Traction Motor: 116.9kW Generator: 82.1kW Li-Ion Battery: 211V, 1.118kWh	€ 2,215	Batt.	48%	€ 1,070	€ 4,012	€ 2,760	€ 1,958	€ 1,440
						Non Batt.	52%	€ 1,145	€ 1,790	€ 1,651	€ 1,324	€ 1,231
						Totals	100%	€ 2,215	€ 5,802	€ 4,410	€ 3,282	€ 2,671
5	0505	A small or mid-sized sports-utility or cross-over vehicle, or a small-midsize SUV, or a Mini Van powered by a 4 cylinder turbocharged engine, direct fuel injection, 6-speed MT or AT & 7 DCT.	Power-split HEV System Power: 132.6kW ICE Power: 108.3kW (I4 -> DS I4) Traction Motor: 88.7kW Generator: 62.2kW Li-Ion Battery: 199V, 1.053 kWh	€ 2,336	Batt.	44%	€ 1,025	€ 3,840	€ 2,642	€ 1,875	€ 1,379	
					Non Batt.	56%	€ 1,311	€ 2,050	€ 1,890	€ 1,516	€ 1,410	
					Totals	100%	€ 2,336	€ 5,891	€ 4,532	€ 3,391	€ 2,788	
6	---	Large sports-utility vehicles, typically powered by a 8 cylinder naturally aspirated engine, direct fuel injection, ≥ 6-speed AT.	n/a	n/a	Batt.	0%	n/a	---	---	---	---	
					Non Batt.	0%	n/a	---	---	---	---	
					Totals	0%	€ 0	---	---	---	---	

E.5 P2 HEV Technology Configuration Evaluated

E.5.1 P2 HEV Technology Overview

E.5.1.1 P2 HEV Technology Configuration Overview

Using the Ford Fusion power-split HEV components and developed costs, and the Hyundai Avante lithium polymer battery module (sold domestically in South Korea) and its developed costs, an incremental cost was developed for a P2 HEV technology configuration, over six (6) different vehicle segments. The basic P2 configuration evaluated, shown in **Figure E-4**, consists of an integrated electric motor/generator and hydraulic clutch module positioned between a downsized internal combustion engine (ICE) and transmission. The electrical power supply/storage system consisted of high-voltage lithium-ion battery pack; voltage and capacity matched to the electric motor/generator size and vehicle mass. The P2 HEV technology configuration considered in this analysis was not considered to have a significant all electric range (AER) capability.

For many of the P2 vehicle systems (e.g., body, brakes, climate control), the incremental direct manufacturing cost impact for P2 and Power-split remained the same. The rationale was based on the fact that similar modifications to these systems would be required independent of HEV configuration. For example, a brake-by-wire brake system for optimizing performance and feel during regenerative brake events, or an electric air conditioning compressor, or auxiliary heater core pump, required when the ICE is not running.

The power-split vehicle system that required the largest change, accounting for differences with respect to the P2 technology, was the transmission system. In the power-split analysis, an electronic continuous variable transmission (e-CVT) replaced the standard 6-speed AT. In the P2 analysis, an electric motor/generator clutch assembly is added between the engine and a standard 6-speed AT (as shown in **Figure E.4**).

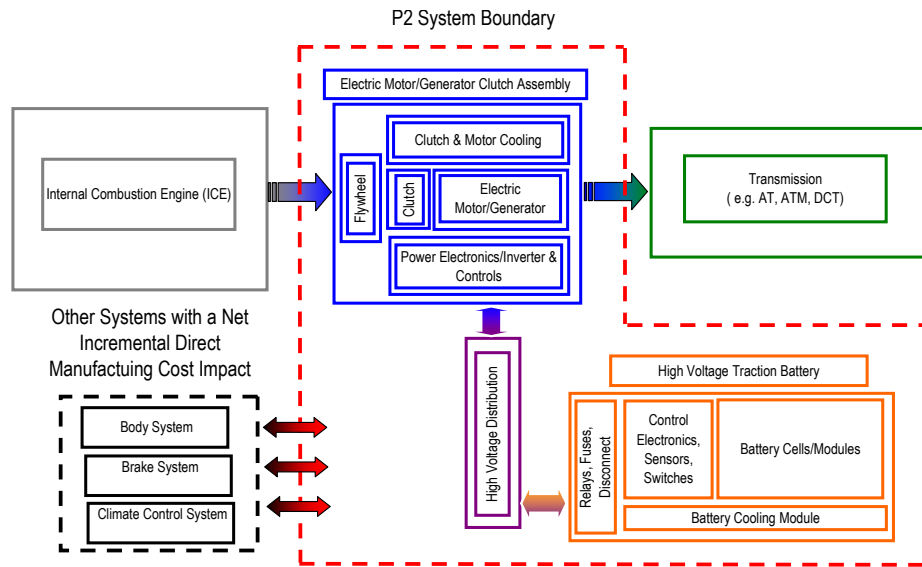

Figure E-4: P2 System Boundary Illustration

E.5.1.2 P2 Assumption Similarities and Differences for the ICCT versus EPA Analysis

The technology configuration (i.e., P2 hardware content) was the same for both the EPA and ICCT analysis. The primary differences, outside of segment attribute differences between European and North American vehicles, existed in assumptions made for sizing the core P2 powertrain hardware.

In the EPA P2 analysis, a vehicle curb weight reduction was considered for most vehicle segments. Note the mass-reduction considered in the EPA P2 analysis was the result of innovations which were not related to hybridization, such as the shift to lighter material throughout the vehicle. The reduction in mass supported a reduction in the net maximum system power and torque, with the exact amount dependent on vehicle segment. As a result of the lower net system power and torque specification for each vehicle segment, a smaller ICE, integrated traction motor/generator and hydraulic clutch module, high voltage traction battery, and transmission were selected.

For the ICCT P2 analysis, no vehicle mass reductions were included. The same curb weights applicable in the power-split analysis were also applicable for the P2 analyses. Keeping vehicle masses consistent between the power-split and P2 studies provided an improved means of comparison on costs.

In both the EPA and ICCT analysis, no reduction in system power or torque was applied to the P2 HEV versus baseline technology configuration.

For both the EPA and ICCT analysis, and for all studies other than the large SUV vehicle segment, the ICE power was assumed to be 80% of the net system HEV power with the

traction motor making up the remaining 20%. For the large SUV segment, the ICE power was kept at 100% of the net system HEV power, which is also equal to the conventional vehicle net system power. The traction motor for the large SUV segment was also sized at 20% of the net system HEV power.

Lastly, within the scope of the EPA P2 analysis, no consideration was given to selecting a specific ICE or transmission technology configuration, nor was a downsizing credit calculated for either of these two (2) systems. For the ICCT analysis ICE downsizing credits were considered as part of the P2 analysis. In addition a credit was taken for eliminating the torque converter based on the assumption that a 6-speed AT is part of the P2 configuration.

In Appendix G, **Table G-4** the conventional vehicle attributes are shown for each vehicle segment evaluated in the P2 analysis. Based on the study assumptions discussed above, **Table G-5** defines sizes of key powertrain components (e.g., net system power, ICE power, traction motor power). **Table G-6** provides the values used in the battery portion of the analysis. Note that many of these same assumptions and values are captured in the various cost analysis tables provide in **Section 5.2**

E.5.1.3 Scaling of Ford Fusion Results to European Case Studies

The scaling methodology applied to the power-split analysis is the same as that used in the P2 analysis. The only difference is the added step in the process to convert the Ford Fusion power-split BOM into a P2 BOM. Using the cost model analysis templates (CMAT) as the foundation, an additional “Technology Configuration” column was added to account for differences in the power-split and P2 costed BOM structure. For example, the power-split e-CVT has two electric machines, one defined as the primary traction motor, the second as a generator. The P2 has one electrical machine performing both duties. In the P2 Traction Motor and Generator CMAT, a “0” placed in the technology configuration column, in the traction motor row, eliminates the motor for the analysis. A “1” placed in the technology configuration column, in the generator row, brings the full cost of the Ford Fusion generator forward. The applicable vehicle segment scaling factors are then applied to the Ford Fusion generator cost, scaling the cost of the motor/generator to each vehicle segment. This part of the process consistent to the scaling of power-split components based on vehicle segment differences.

In addition to placing a “0” in the technology configuration column to eliminate a component in the analysis, or a “1” to include the component in the analysis, fractions are also utilized. For example, to construct an integrated motor/generator clutch assembly module from an eCVT BOM, only a portion of the case subsystem costs would be required. This is based on the fact that with a single electrical machine versus two, there is approximately one-half the power electronics and controls to package, and there is no planetary gear set to package. Conversely, there is a wet clutch requiring additional packaging volume. The wet clutch provides the connection between the ICE and traction

motor. Based on the P2 configuration differences relative to the power-split, 0.50, 1.00 and 0.50 are placed in the technology configuration column for the transaxle case, transaxle housing, and covers, respectively. In this example, 50% of the transaxle case and cover costs are brought forward in the P2 analysis prior to applying any vehicle segment scaling factors; 100% of the costs for the transaxle housing are brought forward.

E.5.2 P2 HEV Cost Analysis Overview

Table E-23 provides the P2 incremental direct manufacturing costs for the six (6) vehicle segments evaluated. The cost impact of the adding the P2 technology is broken out on a vehicle system level basis. In the table header, for each vehicle segment, key powertrain attributes are captured (e.g., curb weight, system power, ICE power, motor/generator power, and battery voltage and capacity).

Table E-24 provides further detail on the incremental direct manufacturing cost contributors by breaking out the key systems cost contributors into subsystem and sub-subsystem (e.g., components, assemblies, modules) costs.

Table E.25 provides a listing of the Indirect Cost Multipliers (ICMs) and Learning factors for the P2 HEV technology and vehicle segments evaluated. As shown in the table, the same ICM factors applied to both battery and non-battery components. Although for the Learning factors different values are used for battery and non-battery component costs. Based on the factors shown in **Table E.25**, the net incremental (direct and indirect) manufacturing costs are calculated and shown in **Table E.26** for production years 2012, 2016, 2020, and 2025.

Table E-23: P2 Technology Configuration, Incremental Direct Manufacturing Costs, System Summary

ICCT Europe Analysis P2 HEV Technnology Configuration							
System ID	System Description	Calculated Incremental Manufacturing Cost - P2 HEV Technology					
		Subcompact Segment, Passenger Seating: 2-4	Compact or Small Segment, Passenger Seating: 2-5	Mid Size Segment, Passenger Seating: 4-5	Mid to Large Size Segment, Passenger Seating: 4-7	Small to Mid Size Sports Utility and Cross Over Segment, Passenger Seating: 4-5	Large Sports Utility Segment, Passenger Seating: 4-7
	Vehicle Example	VW Polo	VW Golf	VW Passat	VW Sharan	VW Tiguan	VW Touareg
Basic Powertrain Parameters	Curb Weight Average "lb" (% Mass Reduction)	2390 (0%)	2803 (0%)	3299 (0%)	3749 (0%)	3513 (0%)	4867 (0%)
	System Power "kW" (hp) (100% Conventional Powertrain)	74.7 (100.2)	90 (120.7)	117 (156.9)	174.8 (234.4)	132.6 (177.7)	271.8 (364.3)
	ICE Power "kW" (hp) (80% System Power w/ exception of Large SUV - No Reduction)	59.8 (80.1)	72 (96.6)	93.6 (125.5)	139.9 (187.5)	106.1 (142.2)	271.8 (364.3)
	Traction Motor Power "kW" (hp) (20% System Power)	14.9 (20)	18 (24.1)	23.4 (31.4)	35.0 (46.9)	26.5 (35.5)	54.3 (72.9)
	High Voltage Battery Capacity "V, kWh"	140, 0.743	162, 0.857	188, 0.994	211, 1.118	199, 1.053	269, 1.427
A	Internal Combustion Engine (ICE) System	(€ 136)	(€ 61)	(€ 61)	(€ 384)	(€ 61)	€ 0
B	Transmission System (Integrated Electric Motor/Generator and Clutch Assembly System + Baseline Transmission System Credit)	€ 568	€ 600	€ 642	€ 726	€ 670	€ 878
C	Body System	€ 6	€ 6	€ 6	€ 6	€ 5	€ 6
D	Brake System	€ 163	€ 167	€ 171	€ 174	€ 172	€ 183
E	Steering System	n/a	n/a	n/a	n/a	n/a	n/a
F	Climate Control System	€ 138	€ 144	€ 152	€ 156	€ 160	€ 184
G	Electric Power Supply System	€ 816	€ 908	€ 1,017	€ 1,109	€ 1,063	€ 1,345
H	Power Distribution and Control System	€ 148	€ 152	€ 155	€ 159	€ 154	€ 160
	Net Incremental Direct Manufacturing Cost	€ 1,704	€ 1,915	€ 2,080	€ 1,947	€ 2,164	€ 2,756

Table E-24: P2 Technology Configuration, Incremental Direct Manufacturing Costs, System/Subsystem Summary

ICCT Europe Analysis P2 HEV Technnology Configuration							
System ID	System Description	Calculated Incremental Manufacturing Cost - P2 HEV Technology					
		Subcompact Segment, Passenger Seating: 2-4	Compact or Small Segment, Passenger Seating: 2-5	Mid Size Segment, Passenger Seating: 4-5	Mid to Large Size Segment, Passenger Seating: 4-7	Small to Mid Size Sports Utility and Cross Over Segment, Passenger Seating: 4-5	Large Sports Utility Segment, Passenger Seating: 4-7
	Vehicle Example	VW Polo	VW Golf	VW Passat	VW Sharan	VW Tiguan	VW Touareg
Basic Powertrain Parameters	Curb Weight Average "lb" (% Mass Reduction)	2390 (0%)	2803 (0%)	3299 (0%)	3749 (0%)	3513 (0%)	4867 (0%)
	System Power "kW" (hp) (100% Conventional Powertrain)	74.7 (100.2)	90 (120.7)	117 (156.9)	174.8 (234.4)	132.6 (177.7)	271.8 (364.3)
	ICE Power "kW" (hp) (80% System Power w/ exception of Large SUV - No Reduction)	59.8 (80.1)	72 (96.6)	93.6 (125.5)	139.9 (187.5)	106.1 (142.2)	271.8 (364.3)
	Traction Motor Power "kW" (hp) (20% System Power)	14.9 (20)	18 (24.1)	23.4 (31.4)	35.0 (46.9)	26.5 (35.5)	54.3 (72.9)
	High Voltage Battery Capacity "V, kWh"	140, 0.743	162, 0.857	188, 0.994	211, 1.118	199, 1.053	269, 1.427
A	Internal Combustion Engine (ICE) System	(€ 136)	(€ 61)	(€ 61)	(€ 384)	(€ 61)	€ 0
B	Transmission System (Integrated Electric Motor/Generator and Clutch Assembly System + Baseline Transmission System Credit)	€ 568	€ 600	€ 642	€ 726	€ 670	€ 878
B.1	Integrated Electric Motor/Generator and Clutch Assembly System	€ 614	€ 649	€ 696	€ 786	€ 726	€ 950
B.1	Case Subsystem	€ 65	€ 70	€ 79	€ 94	€ 84	€ 126
B.2	Launch Clutch Subsystem	€ 43	€ 47	€ 51	€ 57	€ 53	€ 70
B.3	Oil Pump and Filter Subsystem	€ 25	€ 27	€ 30	€ 34	€ 31	€ 43
B.4	Traction Motor/Generator Subsystem	€ 85	€ 91	€ 102	€ 129	€ 111	€ 171
B.5	Power Electronic Components and Assemblies (Large Standalone Passive Components)	€ 47	€ 56	€ 58	€ 64	€ 60	€ 72
B.6	Control Modules (Motor/Generator Control Unit, Transmission Control Unit) Subsystem	€ 175	€ 178	€ 182	€ 192	€ 185	€ 208
B.7	Traction Motor-Generator Sensor Subsystem	€ 29	€ 29	€ 29	€ 29	€ 29	€ 29
B.8	Internal Electrical Connections (e.g. wire harness, terminals, bus bars) Subsystem	€ 33	€ 33	€ 33	€ 33	€ 33	€ 33
B.9	Switch Subsystem	€ 2	€ 2	€ 2	€ 2	€ 2	€ 2
B.10	Electrical Housing/Support Structure Subsystem	€ 15	€ 17	€ 21	€ 29	€ 23	€ 42
B.11	Electric Motor/Generator & Clutch Cooling Subsystem	€ 37	€ 43	€ 52	€ 67	€ 58	€ 96
B.12	Other Misc (e.g. brackets, sealing, etc)	€ 2	€ 2	€ 2	€ 3	€ 2	€ 4
B.13	OE Electric Motor/Generator Clutch System Assembly	€ 54	€ 54	€ 54	€ 54	€ 54	€ 54
B.2	Transmission - Baseline (Credit)	(€ 46)	(€ 49)	(€ 54)	(€ 60)	(€ 56)	(€ 72)

(Table E-24 Continued)

System ID	System Description	Calculated Incremental Manufacturing Cost - P2 HEV Technology					
		Subcompact Segment, Passenger Seating: 2-4	Compact or Small Segment, Passenger Seating: 2-5	Mid Size Segment, Passenger Seating: 4-5	Mid to Large Size Segment, Passenger Seating: 4-7	Small to Mid Size Sports Utility and Cross Over Segment, Passenger Seating: 4-5	Large Sports Utility Segment, Passenger Seating: 4-7
	Vehicle Example	VW Polo	VW Golf	VW Passat	VW Sharan	VW Tiguan	VW Touareg
Basic Powertrain Parameters	Curb Weight Average "lb" (% Mass Reduction)	2390 (0%)	2803 (0%)	3299 (0%)	3749 (0%)	3513 (0%)	4867 (0%)
	System Power "kW" (hp) (100% Conventional Powertrain)	74.7 (100.2)	90 (120.7)	117 (156.9)	174.8 (234.4)	132.6 (177.7)	271.8 (364.3)
	ICE Power "kW" (hp) (80% System Power w/ exception of Large SUV - No Reduction)	59.8 (80.1)	72 (96.6)	93.6 (125.5)	139.9 (187.5)	106.1 (142.2)	271.8 (364.3)
	Traction Motor Power "kW" (hp) (20% System Power)	14.9 (20)	18 (24.1)	23.4 (31.4)	35.0 (46.9)	26.5 (35.5)	54.3 (72.9)
	High Voltage Battery Capacity "V, kWh"	140, 0.743	162, 0.857	188, 0.994	211, 1.118	199, 1.053	269, 1.427
C	Body System	€ 6	€ 6	€ 6	€ 6	€ 5	€ 6
D	Brake System	€ 163	€ 167	€ 171	€ 174	€ 172	€ 183
E	Steering System	n/a	n/a	n/a	n/a	n/a	n/a
F	Climate Control System	€ 138	€ 144	€ 152	€ 156	€ 160	€ 184
F.1	>Electric AC Compressor Subsystem	€ 108	€ 113	€ 118	€ 122	€ 125	€ 144
F.2	> Auxiliary Heating Subsystem	€ 30	€ 32	€ 33	€ 34	€ 35	€ 40
G	Electric Power Supply System	€ 816	€ 908	€ 1,017	€ 1,109	€ 1,063	€ 1,345
G.1	Service Battery Subsystem	(€ 3)	(€ 3)	(€ 3)	(€ 3)	(€ 3)	(€ 3)
G.2	Generator/Alternator and Regulator Subsystem	(€ 57)	(€ 61)	(€ 79)	(€ 83)	(€ 83)	(€ 91)
G.3	High Voltage Traction Battery Subsystem (Li-Ion)	€ 790	€ 879	€ 982	€ 1,070	€ 1,025	€ 1,303
G.3.1	Assembly of Battery	€ 14	€ 14	€ 15	€ 16	€ 15	€ 18
G.3.2	Battery Cells & Cell Modules	€ 449	€ 520	€ 603	€ 674	€ 638	€ 864
G.3.3	Relays/Fuses/Disconnects	€ 124	€ 124	€ 124	€ 124	€ 124	€ 124
G.3.4	Internal Wire Harness Connections	€ 21	€ 22	€ 23	€ 24	€ 23	€ 26
G.3.5	Battery Sensing and Control Modules	€ 133	€ 144	€ 157	€ 168	€ 163	€ 197
G.3.6	Battery Cooling Module Hardware	€ 19	€ 22	€ 25	€ 28	€ 27	€ 36
G.3.7	Misc Components (e.g. Brackets, Housings, Covers)	€ 4	€ 5	€ 5	€ 6	€ 6	€ 8
G.3.8	Vehicle Interfaces (e.g. Brackets, Wiring, etc)	€ 26	€ 27	€ 29	€ 30	€ 28	€ 30
G.4	Voltage Inverters/Converters Subsystem	€ 85	€ 93	€ 116	€ 124	€ 124	€ 135
H	Power Distribution and Control System	€ 148	€ 152	€ 155	€ 159	€ 154	€ 160
	Net Incremental Direct Manufacturing Cost	€ 1,704	€ 1,915	€ 2,080	€ 1,947	€ 2,164	€ 2,756

Table E-25: Application of Indirect Cost Multipliers and Learning Curve Factors to P2 HEVs

Technology ID	Case Study #	Baseline Technology Configuration	New Technology Configuration	Calculated Incremental Direct Manufacturing Cost 2010/2011 Production Year	ICM and Learning Factor Categorization			ICM Factor				Learning Factor			
					Description	Percent Contribution	Calculated Values	ICM-Warranty		ICM-Other Indirect Costs		2012	2016	2020	2025
								Short Term 2012 thru 2018	Long Term 2019 thru 2025	Short Term 2012 thru 2018	Long Term 2019 thru 2025				
P2 HEV	1 0700	Subcompact car typically powered by an inline 4 cylinder engine, naturally aspirated, port fuel injection, 5-speed manual transmission (MT).	P2 HEV System Power: 74.7kW ICE Power: 59.8kW (I4 -> I3) Traction Motor: 14.9kW Li-Ion Battery: 140V, 0.743kWh	€ 1,704	Batt.	46%	€ 790	0.065	0.032	0.499	0.314	3.05	1.95	1.25	1.00
					Non Batt.	54%	€ 913	0.065	0.032	0.499	0.314	1.00	0.89	0.82	0.74
					Totals	100%	€ 1,704								
	2 0701	Compact or small car typically powered by an inline 4 cylinder engine, naturally aspirated, port fuel injection, 6-speed manual transmission or 7-speed dual clutch transmission (DCT).	P2 HEV System Power: 90kW ICE Power: 72kW (I4 -> DS I4) Traction Motor: 18kW Li-Ion Battery: 162V, 0.857kWh	€ 1,915	Batt.	46%	€ 879	0.065	0.032	0.499	0.314	3.05	1.95	1.25	1.00
					Non Batt.	54%	€ 1,036	0.065	0.032	0.499	0.314	1.00	0.89	0.82	0.74
					Totals	100%	€ 1,915								
3 0702	A midsize passenger car typically powered by a 4 cylinder turbocharged, direct fuel injection, 6-speed MT and AT or 7-speed DCT, Start/Stop system.	P2 HEV System Power: 117kW ICE Power: 93.6kW (I4 -> DS I4) Traction Motor: 23.4kW Li-Ion Battery: 188V, 0.994kWh	€ 2,080	Batt.	47%	€ 982	0.065	0.032	0.499	0.314	3.05	1.95	1.25	1.00	
				Non Batt.	53%	€ 1,098	0.065	0.032	0.499	0.314	1.00	0.89	0.82	0.74	
				Totals	100%	€ 2,080									
4 0703	A midsize or large passenger car typically powered by 4 and 6 cylinder turbocharged, direct fuel injection, 6-speed MT or ≥ 6 speed AT.	P2 HEV System Power: 174.8kW ICE Power: 139.9kW (V6 -> I4) Traction Motor: 35.0W Li-Ion Battery: 211V, 1.118 kWh	€ 1,947	Batt.	55%	€ 1,070	0.065	0.032	0.499	0.314	3.05	1.95	1.25	1.00	
				Non Batt.	45%	€ 876	0.065	0.032	0.499	0.314	1.00	0.89	0.82	0.74	
				Totals	100%	€ 1,947									
5 0705	A small or mid-sized sports-utility or cross-over vehicle, or a small-midsize SUV, or a Mini Van powered by a 4 cylinder turbocharged engine, direct fuel injection, 6-speed MT or AT & 7 DCT.	P2 HEV System Power: 132.6kW ICE Power: 106.1kW (I4 -> DS I4) Traction Motor: 26.5kW Li-Ion Battery: 199V, 1.053kWh	€ 2,164	Batt.	47%	€ 1,028	0.065	0.032	0.499	0.314	3.05	1.95	1.25	1.00	
				Non Batt.	53%	€ 1,308	0.065	0.032	0.499	0.314	1.00	0.89	0.82	0.74	
				Totals	100%	€ 2,336									
6 0706	Large sports-utility vehicles, typically powered by a 8 cylinder naturally aspirated engine, direct fuel injection, ≥ 6-speed AT.	P2 HEV System Power: 271.8kW ICE Power: 271.8 kW (No Change to V8) Traction Motor: 54.3 kW Li-Ion Battery: 269V, 1.427kWh	€ 2,756	Batt.	47%	€ 1,303	0.065	0.032	0.499	0.314	3.05	1.95	1.25	1.00	
				Non Batt.	53%	€ 1,453	0.065	0.032	0.499	0.314	1.00	0.89	0.82	0.74	
				Totals	100%	€ 2,756									

Notes: (1) Short Term Period for Power-split and P2 Battery 2012 thru 2024
 (2) Long Term Period for Power-split and P2 Battery 2025+

Table E-26: Net Incremental (Direct + Indirect) Manufacturing Cost for Evaluated P2 HEVs

Technology ID	Case Study #	Baseline Technology Configuration	New Technology Configuration	Calculated Incremental <i>Direct</i> Manufacturing Cost 2010/2011 Production Year	ICM and Learning Factor Categorization			Net Incremental Manufacturing Costs (<i>Direct + Indirect Costs</i>) with Applicable Learning Applied			
					Description	Percent Contribution	Calculated Values	2012	2016	2020	2025
P2 HEV	1	0700	Subcompact car typically powered by an inline 4 cylinder engine, naturally aspirated, port fuel injection, 5-speed manual transmission (MT). P2 HEV System Power: 74.7kW ICE Power: 59.8kW (I4 -> I3) Traction Motor: 14.9kW Li-Ion Battery: 140V, 0.743kWh	€ 1,704	Batt.	46%	€ 790	€ 2,962	€ 2,038	€ 1,446	€ 1,063
					Non Batt.	54%	€ 913	€ 1,428	€ 1,317	€ 1,056	€ 982
					Totals	100%	€ 1,704	€ 4,391	€ 3,355	€ 2,502	€ 2,045
	2	0701	Compact or small car typically powered by an inline 4 cylinder engine, naturally aspirated, port fuel injection, 6-speed manual transmission or 7-speed dual clutch transmission (DCT). P2 HEV System Power: 90kW ICE Power: 72kW (I4 -> DS I4) Traction Motor: 18kW Li-Ion Battery: 162V, 0.857kWh	€ 1,915	Batt.	46%	€ 879	€ 3,293	€ 2,265	€ 1,608	€ 1,182
					Non Batt.	54%	€ 1,036	€ 1,621	€ 1,494	€ 1,198	€ 1,114
					Totals	100%	€ 1,915	€ 4,914	€ 3,760	€ 2,806	€ 2,297
	3	0702	A midsize passenger car typically powered by a 4 cylinder turbocharged, direct fuel injection, 6-speed MT and AT or 7-speed DCT, Start/Stop system. P2 HEV System Power: 117kW ICE Power: 93.6kW (I4 -> DS I4) Traction Motor: 23.4kW Li-Ion Battery: 188V, 0.994kWh	€ 2,080	Batt.	47%	€ 982	€ 3,681	€ 2,532	€ 1,797	€ 1,321
					Non Batt.	53%	€ 1,098	€ 1,718	€ 1,583	€ 1,270	€ 1,181
					Totals	100%	€ 2,080	€ 5,398	€ 4,115	€ 3,067	€ 2,502
	4	0703	A midsize or large passenger car typically powered by 4 and 6 cylinder turbocharged, direct fuel injection, 6-speed MT or ≥ 6 speed AT. P2 HEV System Power: 174.8kW ICE Power: 139.9kW (V6 -> I4) Traction Motor: 35.0W Li-Ion Battery: 211V, 1.118 kWh	€ 1,947	Batt.	55%	€ 1,070	€ 4,012	€ 2,760	€ 1,958	€ 1,440
					Non Batt.	45%	€ 876	€ 1,370	€ 1,263	€ 1,013	€ 942
					Totals	100%	€ 1,947	€ 5,382	€ 4,023	€ 2,972	€ 2,382
	5	0705	A small or mid-sized sports-utility or cross-over vehicle, or a small-midsize SUV, or a Mini Van powered by a 4 cylinder turbocharged engine, direct fuel injection, 6-speed MT or AT & 7 DCT. P2 HEV System Power: 132.6kW ICE Power: 106.1kW (I4 -> DS I4) Traction Motor: 26.5kW Li-Ion Battery: 199V, 1.053kWh	€ 2,164	Batt.	47%	€ 1,025	€ 3,841	€ 2,642	€ 1,875	€ 1,379
					Non Batt.	53%	€ 1,139	€ 1,781	€ 1,642	€ 1,317	€ 1,224
					Totals	100%	€ 2,164	€ 5,621	€ 4,284	€ 3,192	€ 2,603
	6	0706	Large sports-utility vehicles, typically powered by a 8 cylinder naturally aspirated engine, direct fuel injection, ≥ 6-speed AT. P2 HEV System Power: 271.8kW ICE Power: 271.8 kW (No Change to V8) Traction Motor: 54.3 kW Li-Ion Battery: 269V, 1.427kWh	€ 2,756	Batt.	47%	€ 1,303	€ 4,884	€ 3,360	€ 2,384	€ 1,753
					Non Batt.	53%	€ 1,453	€ 2,272	€ 2,095	€ 1,680	€ 1,563
					Totals	100%	€ 2,756	€ 7,156	€ 5,454	€ 4,064	€ 3,316

E.6 Electrical Air Conditioning Compressor Technology Configuration Evaluated

E.6.1 Electrical Air Conditioning Compressor Technology Overview

The air conditioning (AC) compressor cost analysis evaluated the net incremental manufacturing cost between a 2010 Ford Fusion SE conventional mechanical AC compressor relative to a 2010 Ford Fusion HEV electrical AC compressor. In this analysis, only the compressors themselves were evaluated. There is no cost consideration for secondary components required to make either system functional (e.g., high-voltage battery, control module, low-voltage wiring, mechanical belts). These costs are included in the power-split and P2 HEV incremental manufacturing cost analyses.

The belt-driven compressor is a typical piston design (**Figure E-5**) driven by a swash plate. An external electromagnetic clutch is utilized for compressor control. The conventional compressor consists of a two-piece main housing, external electromagnetic clutch (drive pulley), two (2) end caps, a shaft with a swash plate, pistons, and various stamped plates for flow control (reed valves). The compressor clutch is applied by an electromagnet integrated into the compressor's drive pulley area. The magnet, when energized, couples the shaft to the drive pulley, which, in turn, actuates the pistons inside the pump. The magnet consists of a copper wound coil setting inside a U-channel (stamped steel) with a lower insulator and an external potting compound sealing the unit. The magnet is a stationary part fixed to the front of the compressor. The drive pulley consists of the rotating member, which is driven by the accessory drive belt and rides on a sealed bearing. The inner portion of the pulley is attached to the compressor shaft end via splines.



Figure E-5: Belt-Driven Compressor and Mounting Hardware

The electric compressor, including electronic controls, is completely self-contained (**Figure E-6**). The compressor is a scroll design, unlike the gas piston version. Although it could have been located virtually anywhere between the evaporator and condenser, it is

attached directly to the engine in the same location as the mechanical compressor. The compressor receives power from the same high-voltage battery used to power the traction motor in the Fusion power-split e-CVT.

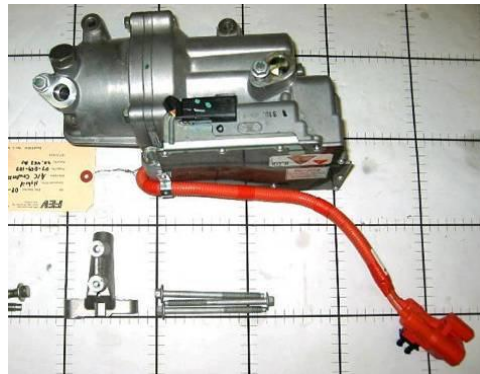

Figure E-6: Electric Compressor and Mounting Hardware

The compressor assembly consists of a main housing, end cap (scroll housing), scroll, electronic controls, and a short harness assembly. The main housing is a machined die cast aluminum part. One end has a bore for the electric motor and scroll mounting. The top of the housing contains a stepped pocket (cavity) for the electronics.

The main housing electrical cavity which houses all of the electronic components is filled with potting compound. Two (2) Printed Circuit Boards (PCBs) and a separate IGBT mount plate (heat sink) are located inside the housing along with various coils, terminal blocks, and a capacitor.

A High-Voltage Low-Current (HVLC) pigtail is attached to the compressor and connected to the High-Voltage (HV) harness in the engine compartment. As with the main harness, the pigtail contains EMI shielding and safety interlocks for power disconnect during service.

The synchronous electric motor's stator and rotor are contained inside the main housing. The stator sits inside the main housing, while the rotor is preassembled to a shaft and intermediate plate. The rotor shaft is mounted to an intermediate plate that provides the oscillating motion for the scroll by utilizing an eccentric drive design on the end of the shaft.

The scroll housing is a machined aluminum die casting which mounts to the end of the AC compressor. This housing contains both inlet and outlet ports for the AC refrigerant.

E.6.2 Electrical Air Compressor Cost Analysis Overview

The incremental direct manufacturing costs, for the AC compressor comparison analysis are provided in **Table E-27** for the six (6) vehicle segments evaluated. The table also

contains the ICM and Learning factors used to develop the net incremental manufacturing costs.

Contained with the electrical AC compressor (application: midsized vehicle segment), approximately 52% of the compressor costs (€89) are associated with low and high power electronic components. The electrical motor (i.e., rotor and stator) contribute approximate 17% of the costs (€29). The remaining costs (€53) are associated with cast housings, compressor scrolls, bearings, seals, and miscellaneous hardware.

In an equivalent performance mechanical AC compressor, 30% (€18) of the compressor costs are associated with the magnetic clutch and pulley assembly. Approximately 26% (€16) of the costs are associated with the swash plate, pistons, and valves. The housings, bearings, seals, and other miscellaneous hardware make up the balance of the costs (€27).

In **Table E-28**, the net incremental manufacturing costs of an electrical AC compressor compared to a mechanical conventional AC compressor are present for six (6) vehicle segments. The net incremental manufacturing costs are calculated using the ICM and Learning factors provided in **Table E-27**.

Table E-27: Application of Indirect Cost Multipliers and Learning Curve Factors to Electrical Air Conditioning Compressor Technology

Technology ID	Case Study #	Baseline Technology Configuration	New Technology Configuration	Calculated Incremental <u>Direct</u> Manufacturing Cost 2010/2011 Production Year	ICM and Learning Factor Categorization			ICM Factor				Learning Factor			
					Description	Percent Contribution	Calculated Values	ICM-Warranty		ICM-Other Indirect Costs		2012	2016	2020	2025
								Short Term 2012 thru 2018	Long Term 2019 thru 2025	Short Term 2012 thru 2018	Long Term 2019 thru 2025				
Electrical Air Conditioning Compressor Subsystem	1 0600	Mechanical Air Conditioning Compressor Subsystem	Electrical Air Conditioning Compressor Subsystem	€ 102	n/a	n/a	n/a	0.065	0.032	0.499	0.314	1.00	0.89	0.82	0.74
	2 0601	Mechanical Air Conditioning Compressor Subsystem	Electrical Air Conditioning Compressor Subsystem	€ 106	n/a	n/a	n/a	0.065	0.032	0.499	0.314	1.00	0.89	0.82	0.74
	3 0602	Mechanical Air Conditioning Compressor Subsystem	Electrical Air Conditioning Compressor Subsystem	€ 111	n/a	n/a	n/a	0.065	0.032	0.499	0.314	1.00	0.89	0.82	0.74
	4 0603	Mechanical Air Conditioning Compressor Subsystem	Electrical Air Conditioning Compressor Subsystem	€ 115	n/a	n/a	n/a	0.065	0.032	0.499	0.314	1.00	0.89	0.82	0.74
	5 0605	Mechanical Air Conditioning Compressor Subsystem	Electrical Air Conditioning Compressor Subsystem	€ 118	n/a	n/a	n/a	0.065	0.032	0.499	0.314	1.00	0.89	0.82	0.74
	6 0606	Mechanical Air Conditioning Compressor Subsystem	Electrical Air Conditioning Compressor Subsystem	€ 135	n/a	n/a	n/a	0.065	0.032	0.499	0.314	1.00	0.89	0.82	0.74

Table E-28: Net Incremental (Direct + Indirect) Manufacturing Cost for Evaluated Electrical Air Conditioning Compressors

Technology ID	Case Study #	Baseline Technology Configuration	New Technology Configuration	Calculated Incremental <u>Direct</u> Manufacturing Cost 2010/2011 Production Year	ICM and Learning Factor Categorization			Net Incremental Manufacturing Costs (<u>Direct + Indirect Costs</u>) with Applicable Learning Applied			
					Description	Percent Contribution	Calculated Values	2012	2016	2020	2025
Electrical Air Conditioning Compressor Subsystem	1 0600	Mechanical Air Conditioning Compressor Subsystem	Electrical Air Conditioning Compressor Subsystem	€ 102	n/a	n/a	n/a	€ 159	€ 146	€ 117	€ 109
	2 0601	Mechanical Air Conditioning Compressor Subsystem	Electrical Air Conditioning Compressor Subsystem	€ 106	n/a	n/a	n/a	€ 166	€ 153	€ 123	€ 114
	3 0602	Mechanical Air Conditioning Compressor Subsystem	Electrical Air Conditioning Compressor Subsystem	€ 111	n/a	n/a	n/a	€ 174	€ 161	€ 129	€ 120
	4 0603	Mechanical Air Conditioning Compressor Subsystem	Electrical Air Conditioning Compressor Subsystem	€ 115	n/a	n/a	n/a	€ 180	€ 166	€ 133	€ 124
	5 0605	Mechanical Air Conditioning Compressor Subsystem	Electrical Air Conditioning Compressor Subsystem	€ 118	n/a	n/a	n/a	€ 184	€ 169	€ 136	€ 126
	6 0606	Mechanical Air Conditioning Compressor Subsystem	Electrical Air Conditioning Compressor Subsystem	€ 135	n/a	n/a	n/a	€ 212	€ 195	€ 157	€ 146

F. Sensitivity Analysis

As stated in **Section C.3** (Labor Databases), the labor rates employed in the analysis were based on values acquired from Germany's Federal Statistical Office. This supported the analysis assumption that all components are manufactured in Germany using a Germany manufacturing infrastructure. In reality, automotive vehicles and parts for vehicles are manufactured worldwide, taking advantage of regions of technology expertise as well as cost competitiveness. The decision to manufacture and/or purchase a component from a given region varies from supplier to supplier, from OEM to OEM, and is based on a multitude of factors.

No attempt was made within the scope of this analysis to try and determine which types of powertrain components were likely to come from the various manufacturing regions. Rather, the approach was based on establishing a common set of boundary conditions, applied for all technologies under evaluation, resulting in a level playing field for comparison.

In understanding how the incremental costs are developed, having sufficient details on the cost breakdowns (e.g. material, labor, manufacturing overhead, markup), and understanding what boundary conditions are used in the analysis, assumption modifications can be made and sensitivity to the cost impact evaluated. For example, in **Figure F-1**, the average labor rate percentages relative to Germany are shown for several Eastern Europe countries. The average is approximately 23.3% that of Germany's average manufacturing labor rate.

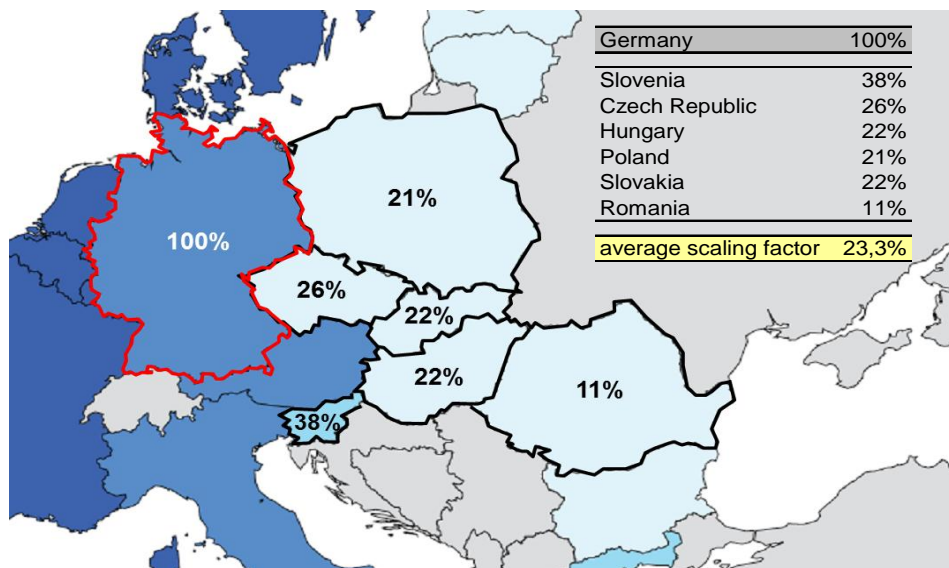

Figure F-1: Eastern Europe Labor Rate Averages Relative to Germany

Table F-1 provides a rough order of magnitude estimate on the impact of incremental direct manufacturing costs associated with relocating the manufacturing from Germany to an Eastern European country with a lower labor rate. In actuality, many other aspects of the manufacturing and cost structure would change (positively and negatively) with producing parts where labor rates are much lower (e.g., more manual operations, longer takt times, lower burden rates, higher quality risk). However, these types of quick analyses can provide some directional insight on the risk and opportunities associated with change, such as relocating to a lower cost country.

The examples shown in **Table F-1** include three (3) engine downsizing, turbocharging, gasoline direct inject engine analyses. A reduction in labor costs results in a reduction in the overall incremental direct manufacturing costs ranging from 16.2-56.9%.

Table F-1: Labor Rate Sensitivity Analysis on Three Engine Downsizing, Turbocharging, Gasoline Direct Injection Engines Analyses

Case Study	Downsized, Turbocharged, Gasoline Direct Injection Engine Analysis	Incremental Direct Manufacturing Cost (Germany) _A	Reduction in Average Labor Rate (Eastern Europe) (100%-23.3%)	Incremental Direct Manufacturing Cost (Eastern Europe) _B	Absolute Reduction In Incremental Direct Manufacturing Cost (A-B)	Percent Reduction In Incremental Direct Manufacturing Cost (1-B/A)
#0102	I4-> Smaller I4	€ 367	76.7%	€ 308	€ 60	16.2%
#0103	V6 -> I4	€ 80	76.7%	€ 35	€ 46	56.9%
#0106	V8 -> V6	€ 648	76.7%	€ 537	€ 112	17.3%

G. Appendix

This appendix contains the selected supporting figures and tables used in the cost analyses. The section is structured in the following manner:

- Appendix G.1: Vehicle Segment Attribute Database Summary File Cost Model Inputs
- Appendix G.2: Manufacturing Assumption and Quote Summary (MAQS) Worksheet Overview

G.1 Vehicle Segment Attribute Database Summary File Cost Model Inputs

Table G-1: Power-split Vehicle Segment Attribute Database File, Part 1 of 3, Base Powertrain and Vehicle Attributes







Power-Split Hybrid Electric Vehicle Analysis			Baseline Technology Configuration: Internal Combustion Engine (ICE), Transmission and Vehicle Size and Performance Attributes										
DATA SET		5	Typical Engine Configuration & Displacement Range	Typical Transmission Configuration	Curb Weight	ICE Power Max		ICE Torque Max		Wheel Base	Track Width	Vehicle Length	Passenger Volume
Vehicle Class Description	Occupancy/Towing and/or Car Examples	"lbs"				"kW"	"hp"	"N·m"	"lb·ft"				
1	Subcompact car typically powered by an inline 4 cylinder engine, naturally aspirated, port fuel injection, 5-speed manual transmission (MT). 	Subcompact Passenger Vehicle (Passenger Seating 2-4) e.g. VW Polo, Ford Fiesta	I4 1.2-1.4L	5-Speed MT	2390	75	100	146	108	2502	1469	3949	2.49
2	Compact or small car typically powered by an inline 4 cylinder engine, naturally aspirated, port fuel injection, 6-speed manual transmission or 7-speed dual clutch transmission (DCT). 	Compact/Small Passenger Vehicle (Passenger Seating 2-5) e.g. VW Golf, Ford Focus	I4 1.4-1.6L	6-Speed MT 7-Speed DCT	2803	90	121	179	132	2631	1531	4299	2.60
3	A midsize passenger car typically powered by a 4 cylinder turbocharged, direct fuel injection, 6-speed MT and AT or 7-speed DCT, Start/Stop system. 	Midsize Passenger Vehicle (Passenger Seating 4-5) e.g. VW Passat, Audi A4	I4 1.6-2.0L	6-Speed MT 6-Speed AT 7-Speed DCT	3299	117	157	235	174	2758	1562	4666	2.73
4	A midsize or large passenger car typically powered by a 6 cylinder turbocharged, direct fuel injection, 6-speed MT or ≥ 6 speed AT. 	Passenger Vehicle (Passenger Seating 4-7) e.g. VW Sharan, Audi A6	I4, I6, V6 2.0-3.0L	6-Speed MT ≥6-Speed AT	3749	175	234	322	237	2890	1593	4872	2.82
6	A small or mid-sized sports-utility or cross-over vehicle, or a small-midsize SUV, or a Mini Van powered by a 4 cylinder turbocharged engine, direct fuel injection, 6-speed MT or AT & 7 DCT. 	Small & Midsize SUV/COV (Passenger + Minivan) e.g. VW Tiguan, Audi Q5	I4, I6 1.2-3.0L	6-Speed MT 6-Speed AT 7-Speed DCT	3513	133	178	265	195	2733	1392	4488	2.88
7	Large sports-utility vehicles, typically powered by a 8 cylinder naturally aspirated engine, direct fuel injection, ≥ 6 speed AT. 	Large SUV w/ Strong Towing Capability e.g. VW Touareg, Audi Q7	I6, V6, V8 (3.0-5.5)	≥6-Speed AT	4867	272	364	491	362	2947	1466	4924	3.32

Table G-2: Power-split Vehicle Segment Attribute Database File, Part 2 of 3, ICE, Electric Traction Motor and Electric Generator Sizing







Power-Split Hybrid Electric Vehicle Analysis			New Technology Configuration (Power-split): ICE, Transmission, Electric Motor, and Electric Generator											
DATA SET		5	HEV Maximum System Power		HEV Maximum System Torque (86% Conventional Powertrain Net System Torque)		HEV Maximum ICE Power (82% of HEV Net System Power)		HEV Maximum ICE Torque (82% of HEV Net System Torque)		Maximum Traction Motor Power (67% of HEV Net System Power)		Maximum Generator Motor Power (47% of HEV Net System Power)	
Vehicle Class #	Vehicle Class Description	Occupancy/Towing and/or Car Examples	"kW"	"hp"	"N·m"	"lb·ft"	"kW"	"hp"	"N·m"	"lb·ft"	"kW"	"hp"	"kW"	"hp"
1	Subcompact car typically powered by an inline 4 cylinder engine, naturally aspirated, port fuel injection, 5-speed manual transmission (MT).	 Subcompact Passenger Vehicle (Passenger Seating 2-4) e.g. VW Polo, Ford Fiesta	75	100	146	108	61	82	119	88	50	67	35	47
2	Compact or small car typically powered by an inline 4 cylinder engine, naturally aspirated, port fuel injection, 6-speed manual transmission or 7-speed dual clutch transmission (DCT).	 Compact/Small Passenger Vehicle (Passenger Seating 2-5) e.g. VW Golf, Ford Focus	90	121	179	132	74	99	146	108	60	81	42	57
3	A midsize passenger car typically powered by a 4 cylinder turbocharged, direct fuel injection, 6-speed MT and AT or 7-speed DCT, Start/Stop system.	 Midsize Passenger Vehicle (Passenger Seating 4-5) e.g. VW Passat, Audi A4	117	157	235	174	96	128	192	142	78	105	55	74
4	A midsize or large passenger car typically powered by a 6 cylinder turbocharged, direct fuel injection, 6-speed MT or ≥ 6 speed AT.	 Passenger Vehicle (Passenger Seating 4-7) e.g. VW Sharan, Audi A6	175	234	322	237	143	191	263	194	117	157	82	110
6	A small or mid-sized sports-utility or cross-over vehicle, or a small-midsize SUV, or a Mini Van powered by a 4 cylinder turbocharged engine, direct fuel injection, 6-speed MT or AT & 7 DCT.	 Small & Midsize SUV/COV (Passenger + Minivan) e.g. VW Tiguan, Audi Q5	133	178	265	195	108	145	216	159	89	119	62	83
7	Large sports-utility vehicles, typically powered by a 8 cylinder naturally aspirated engine, direct fuel injection, ≥ 6-speed AT.	 Large SUV w/ Strong Towing Capability e.g. VW Touareg, Audi Q7	165	221	302	223	135	181	247	182	110	148	77	104

Table G-3: Power-split Vehicle Segment Attribute Database File, Part 3 of 3, High Voltage Traction Motor Battery Sizing







Power-Split Hybrid Electric Vehicle Analysis			High Voltage Traction Motor Battery Sizing (Based on Lithium Ion Battery from 2010 Hyundai Avante HEV: 180V, 5.3Ah Battery, 6 Modules, 8 Cells per Module)						
DATA SET		5	Nominal Battery Capacity Based on Vehicle Mass (Curb Weight + 300lbs) x 0.27622Wh/lb	Nominal Battery Current Capacity	Nominal Battery Pack Voltage	Average Cell Voltage	Average Number of Battery Cells	Average Number of Battery Modules	Average Run Time (Max Power Consumption)
Vehicle Class Description	Occupancy/Towing and/or Car Examples	"kWh"	"Ah"	"V"	"V"	"qty"	"qty"	"seconds"	
1 Subcompact car typically powered by an inline 4 cylinder engine, naturally aspirated, port fuel injection, 5-speed manual transmission (MT).	 Subcompact Passenger Vehicle (Passenger Seating 2-4) e.g. VW Polo, Ford Fiesta	0.743	5.3	140	3.75	38	5	31	
2 Compact or small car typically powered by an inline 4 cylinder engine, naturally aspirated, port fuel injection, 6-speed manual transmission or 7-speed dual clutch transmission (DCT).	 Compact/Small Passenger Vehicle (Passenger Seating 2-5) e.g. VW Golf, Ford Focus	0.857	5.3	162	3.75	44	6	30	
3 A midsize passenger car typically powered by a 4 cylinder turbocharged, direct fuel injection, 6-speed MT and AT or 7-speed DCT, Start/Stop system.	 Midsize Passenger Vehicle (Passenger Seating 4-5) e.g. VW Passat, Audi A4	0.994	5.3	188	3.75	51	7	27	
4 A midsize or large passenger car typically powered by a 6 cylinder turbocharged, direct fuel injection, 6-speed MT or ≥ 6 speed AT.	 Passenger Vehicle (Passenger Seating 4-7) e.g. VW Sharan, Audi A6	1.118	5.3	211	3.75	57	8	20	
6 A small or mid-sized sports-utility or cross-over vehicle, or a small-midsize SUV, or a Mini Van powered by a 4 cylinder turbocharged engine, direct fuel injection, 6-speed MT or AT & 7 DCT.	 Small & Midsize SUV/COV (Passenger + Minivan) e.g. VW Tiguan, Audi Q5	1.053	5.3	199	3.75	53	7	25	
7 Large sports-utility vehicles, typically powered by a 8 cylinder naturally aspirated engine, direct fuel injection, ≥ 6-speed AT.	 Large SUV w/ Strong Towing Capability e.g. VW Touareg, Audi Q7	1.427	5.3	269	3.75	72	9	27	

Table G-4: P2 Vehicle Segment Attribute Database File, Part 1 of 3, Base Powertrain and Vehicle Attributes







P2 Hybrid Electric Vehicle Analysis			Baseline Technology Configuration: Internal Combustion Engine (ICE), Transmission and Vehicle Size and Performance Attributes										
DATA SET		4	Typical Engine Configuration & Displacement Range	Typical Transmission Configuration	Curb Weight	ICE Power Max		ICE Torque Max		Wheel Base	Track Width	Vehicle Length	Passenger Volume
Vehicle Class Description	Occupancy/Towing and/or Car Examples	"lbs"				"kW"	"hp"	"N·m"	"lb·ft"				
1	Subcompact car typically powered by an inline 4 cylinder engine, naturally aspirated, port fuel injection, 5-speed manual transmission (MT). 	Subcompact Passenger Vehicle (Passenger Seating 2-4) e.g. VW Polo, Ford Fiesta	I4 1.2-1.4L	5-Speed MT	2390	75	100	146	108	2502	1469	3949	2.49
2	Compact or small car typically powered by an inline 4 cylinder engine, naturally aspirated, port fuel injection, 6-speed manual transmission or 7-speed dual clutch transmission (DCT). 	Compact/Small Passenger Vehicle (Passenger Seating 2-5) e.g. VW Golf, Ford Focus	I4 1.4-1.6L	6-Speed MT 7-Speed DCT	2803	90	121	179	132	2631	1531	4299	2.60
3	A midsize passenger car typically powered by a 4 cylinder turbocharged, direct fuel injection, 6-speed MT and AT or 7-speed DCT, Start/Stop system. 	Midsize Passenger Vehicle (Passenger Seating 4-5) e.g. VW Passat, Audi A4	I4 1.6-2.0L	6-Speed MT 6-Speed AT 7-Speed DCT	3299	117	157	235	174	2758	1562	4666	2.73
4	A midsize or large passenger car typically powered by a 6 cylinder turbocharged, direct fuel injection, 6-speed MT or ≥ 6 speed AT. 	Passenger Vehicle (Passenger Seating 4-7) e.g. VW Sharan, Audi A6	I4, I6, V6 2.0-3.0L	6-Speed MT ≥6-Speed AT	3749	175	234	322	237	2890	1593	4872	2.82
6	A small or mid-sized sports-utility or cross-over vehicle, or a small-midsize SUV, or a Mini Van powered by a 4 cylinder turbocharged engine, direct fuel injection, 6-speed MT or AT & 7 DCT. 	Small & Midsize SUV/COV (Passenger + Minivan) e.g. VW Tiguan, Audi Q5	I4, I6 1.2-3.0L	6-Speed MT 6-Speed AT 7-Speed DCT	3513	133	178	265	195	2733	1392	4488	2.88
7	Large sports-utility vehicles, typically powered by a 8 cylinder naturally aspirated engine, direct fuel injection, ≥ 6-speed AT. 	Large SUV w/ Strong Towing Capability e.g. VW Touareg, Audi Q7	I6, V6, V8 3.0-5.5	≥6-Speed AT	4867	272	364	491	362	2947	1466	4924	3.32

Table G-5: P2 Vehicle Segment Attribute Database File, Part 2 of 3, ICE, Electric Traction Motor and Electric Generator Sizing













P2 Hybrid Electric Vehicle Analysis		New Technology Configuration (P2): ICE, Transmission, and Electric Motor/Generator Sizing											
DATA SET		4											
ID #	Vehicle Class Description	Occupancy/Towing and/or Car Examples	Percent HEV Powertrain Net System Power (NSP) relative to the Conventional Powertrain NSP	Percent Internal Combustion Engine Power as a Percent of HEV NSP	Percent Traction Motor/Generator Power as a Percent of HEV NSP	HEV Maximum System Power		HEV Maximum System Torque		HEV Maximum ICE Power		Maximum Traction Motor/Generator Power	
			"%"	"%"	"%"	"kW"	"hp"	"N·m"	"lb·ft"	"kW"	"hp"	"kW"	"hp"
1	Subcompact car typically powered by an inline 4 cylinder engine, naturally aspirated, port fuel injection, 5-speed manual transmission (MT).	 Subcompact Passenger Vehicle (Passenger Seating 2-4) e.g. VW Polo, Ford Fiesta	100%	80%	20%	75	100	146	108	60	80	15	20
2	Compact or small car typically powered by an inline 4 cylinder engine, naturally aspirated, port fuel injection, 6-speed manual transmission or 7-speed dual clutch transmission (DCT).	 Compact/Small Passenger Vehicle (Passenger Seating 2-5) e.g. VW Golf, Ford Focus	100%	80%	20%	90	121	179	132	72	97	18	24
3	A midsize passenger car typically powered by a 4 cylinder turbocharged, direct fuel injection, 6-speed MT and AT or 7-speed DCT, Start/Stop system.	 Midsize Passenger Vehicle (Passenger Seating 4-5) e.g. VW Passat, Audi A4	100%	80%	20%	117	157	235	174	94	126	23	31
4	A midsize or large passenger car typically powered by a 6 cylinder turbocharged, direct fuel injection, 6-speed MT or ≥ 6 speed AT.	 Passenger Vehicle (Passenger Seating 4-7) e.g. VW Sharan, Audi A6	100%	80%	20%	175	234	322	237	140	187	35	47
6	A small or mid-sized sports-utility or cross-over vehicle, or a small-midsize SUV, or a Mini Van powered by a 4 cylinder turbocharged engine, direct fuel injection, 6-speed MT or AT & 7 DCT.	 Small & Midsize SUV/COV (Passenger + Minivan) e.g. VW Tiguan, Audi Q5	100%	80%	20%	133	178	265	195	106	142	27	36
7	Large sports-utility vehicles, typically powered by a 8 cylinder naturally aspirated engine, direct fuel injection, ≥ 6-speed AT.	 Large SUV w/ Strong Towing Capability e.g. VW Touareg, Audi Q7	100%	100%	20%	272	364	491	362	272	364	54	73

Table G-6: P2Vehicle Segment Attribute Database File, Part 3 of 3, High Voltage Traction Motor Battery Sizing

P2 Hybrid Electric Vehicle Analysis		High Voltage Traction Motor Battery Sizing (Based on Lithium Ion Battery from 2010 Hyundai Avante HEV: 180V, 5.3Ah Battery, 6 Modules, 8 Cells per Module)						
DATA SET	4	Nominal Battery Capacity Based on Vehicle Mass (Curb Weight + 300lbs) x 0.27622Wh/lb	Nominal Battery Current Capacity	Nominal Battery Pack Voltage	Average Cell Voltage	Average Number of Battery Cells	Average Number of Battery Modules	Average Run Time (Max Power Consumption)
Vehicle Class Description	Occupancy/Towing and/or Car Examples	"kWh"	"A·h"	"V"	"V"	"qty"	"qty"	"seconds"
1 Subcompact car typically powered by an inline 4 cylinder engine, naturally aspirated, port fuel injection, 5-speed manual transmission (MT).	 Subcompact Passenger Vehicle (Passenger Seating 2-4) e.g. VW Polo, Ford Fiesta	0.743	5.3	140	3.75	38	5	179
2 Compact or small car typically powered by an inline 4 cylinder engine, naturally aspirated, port fuel injection, 5-speed manual transmission or 7-speed dual clutch transmission (DCT).	 Compact/Small Passenger Vehicle (Passenger Seating 2-5) e.g. VW Golf, Ford Focus	0.857	5.3	162	3.75	44	6	171
3 A midsize passenger car typically powered by a 4 cylinder turbocharged, direct fuel injection, 6-speed MT and AT or 7-speed DCT, Start/Stop system.	 Midsize Passenger Vehicle (Passenger Seating 4-5) e.g. VW Passat, Audi A4	0.994	5.3	188	3.75	51	7	153
4 A midsize or large passenger car typically powered by a 6 cylinder turbocharged, direct fuel injection, 6-speed MT or ≥ 6 speed AT.	 Passenger Vehicle (Passenger Seating 4-7) e.g. VW Sharan, Audi A6	1.118	5.3	211	3.75	57	8	115
6 A small or mid-sized sports-utility or cross-over vehicle, or a small-midsize SUV, or a Mini Van powered by a 4 cylinder turbocharged engine, direct fuel injection, 6-speed MT or AT & 7 DCT.	 Small & Midsize SUV/COV (Passenger + Minivan) e.g. VW Tiguan, Audi Q5	1.053	5.3	199	3.75	53	7	143
7 Large sports-utility vehicles, typically powered by a 8 cylinder naturally aspirated engine, direct fuel injection, ≥ 6-speed AT.	 Large SUV w/ Strong Towing Capability e.g. VW Touareg, Audi Q7	1.427	5.3	269	3.75	72	9	95

G.2 Main Sections of Manufacturing Assumption and Quote Summary Worksheet

The MAQS worksheet, as shown in

Figure G-1 and **Figure G-2**, contains seven (7) major sections. At the top of every MAQS worksheet is an information header (*Section A*), which captures the basic project details along with the primary quote assumptions. The project detail section references the MAQS worksheet back to the applicable CBOM. The primary quote assumption section provides the basic information needed to put together a quote for a component/assembly. Some of the parameters in the quote assumption section are automatically referenced/linked throughout the MAQS worksheet, such as capacity planning volumes, product life span, and OEM/T1 classification. The remaining parameters in this section including facility locations, shipping methods, packing specifications, and component quote level are manually considered for certain calculations.

Two (2) parameters above, which functions perhaps are not so evident from their names are the “OEM/T1 classification” and “component quote level.”

The “OEM/T1 classification” parameter addresses who was taking the lead on manufacturing the end-item component, the OEM or Tier 1 supplier. Also captured is the OEM or Tier 1 level, as defined by size, complexity, and expertise level. The value entered into the cell was linked to the Mark-up Database, which will up-load the corresponding mark-up values from the database into the MAQS worksheet. For example, if “T1 High Assembly Complexity” is entered in the input cell, the following values for mark-up are pulled into the worksheet: Scrap = 0.70%, SG&A = 7%, Profit = 8.0% and ED&T = 4%. These rates were then multiplied by the TMC at the bottom of the MAQS worksheet to calculate the applied mark-up as shown in **Figure G-3**.

The process for selecting the classification of the lead manufacturing site (OEM or T1) and corresponding complexity (e.g., High Assembly Complexity, Moderate Assembly Complexity, Low Assembly Complexity) was based on the team’s knowledge of existing value chains for same or similar type components.

GENERAL COMPONENT INFORMATION		GENERAL MANUFACTURING INFORMATION							MANUFACTURING COSTS					MARKUP COSTS				TOTAL COSTS												
Reference #	Part Description	Part Number	QTY Per Assembly	Primary Process Description	OEM Supplier Classification	Material Specification	Labor Classification	Burden Classification	Finished Pieces Per Hour	Number of Operators	Parallel Processing Multiplier	Material Usage "lbs"	Material Cost (DB)	Labor Rate (PB)	Burden Rate (PB)	Applied Burden \$/Hour	Material Cost	Labor/Pct	Burden/Pct	Total 1 = Material + Labor + Burden	Scrap Rate (DB)	SG&A Rate (DB)	Profit Rate (DB)	EDAT/R&D Rate (DB)	Total Mark-up Rate Cost	Total 2 = Total 1 + Total Mark-up	Total 3 = Total 2 * Qty per Ass'y	Tooling Assumptions "x1000"	Investment Assumptions "x1000"	
<p>SECTION A</p> <p>Technology Level: Downmixed, Turbocharged, Gasoline Direct Inject (GDI) Engine/Compact Vehicle Class Vehicle Class: Compact/Economy 2.4 Passenger Study Class: N031 M = New, 01 = Technology Package, 01 = Vehicle Class System Description: 2007 Mini Cooper S, LILIL, 16V, DOHC, GDI Turbo Component Description: Fuel Injector Assembly - Solenoid, 3 Hole Component Quote Level: Full Date <input checked="" type="checkbox"/> Modification Only <input type="checkbox"/> Differential Quote (Quote Summary includes)</p> <p>OEM Operating Pattern (Weeks/year): 47 Annual Engine Volume (CPV): 450,000 Components per Engine: 4 Weekly Component Volume: 13,298 Estimated Product Life: 10 OEM Plant Location: North America Supplier Plant Location: North America OEM/T1 Classification: T High Assembly Company Shipping Method: FOB Ship Point Packaging Specification: Reusable Container & Internal Damage</p>																														
	Tier 1 Supplier or OEM Processing & Assembly (Full Cost Mapping)																													
1A	Fuel Injector Assembly	104-K070-01-01	1	Final Assembly	T1 Assembly/ Markup Applied @ BOM	Not Applicable	Electromechanical Assembly	Mech Assembly, LC Base	489	2	1	6	0.000	\$8.00	\$17.35	\$16.88	\$88.80	\$8.00	\$6.19	\$8.34	0.00%	0.00%	0.00%	0.00%	\$8.34	\$8.34	30.34			
2A	Solenoid Tip	104-K070-01-03	1	Downmix and @ Inlet Tip	T1 Assembly/ Markup Applied @ BOM	Hydro-VT Inlet	Electromechanical Assembly	Mech Assembly, MC Base	438	1	1	1	0.005	\$4.00	\$17.35	\$38.80	\$8.00	\$8.08	\$8.07	\$8.07	0.00%	0.00%	0.00%	0.00%	\$8.07	\$8.07	30.17			
3A	Solenoid Body pre-assembly	104-K070-01-10	1	Inlet/Wiring Ring, Center	T1 Assembly/ Markup Applied @ BOM	Hydro-VDFR, Inlet	Electromechanical Assembly	Mech Assembly, MC Base	438	2	1	5	0.030	\$1.54	\$17.35	\$48.80	\$28.99	\$8.07	\$8.08	\$8.71	0.00%	0.00%	0.00%	0.00%	\$8.71	\$8.71	30.71			
4A	Vehicle Body Assembly	104-K070-01-50	1	Liner weld/diffuse weld assembly	T1 Assembly/ Markup Applied @ BOM	Not Applicable	Electromechanical Assembly	Mech Assembly, MC Base	459	4	1.5	8	0.000	\$8.00	\$17.35	\$38.80	\$38.80	\$8.30	\$8.30	\$1.13	0.00%	0.00%	0.00%	0.00%	\$8.30	\$1.13	\$1.13			
5A	Vehicle Assembly	104-K070-01-11	1	Headstud & Pinns Shims	T1 Assembly/ Markup Applied @ BOM	Not Applicable	Electromechanical Assembly	Mech Assembly, MC Base	459	1	4	0.000	\$8.00	\$17.35	\$38.80	\$38.80	\$8.08	\$8.08	\$8.35	0.00%	0.00%	0.00%	0.00%	\$8.35	\$8.35	30.35				
6A	Headset Injector	104-K070-01-13	1	Liner Weld Ball and Seat b Nuts	T1 Assembly/ Markup Applied @ BOM	Not Applicable	Electromechanical Assembly	Mech Assembly, MC Base	514	1	1	3	0.000	\$8.00	\$17.35	\$38.80	\$8.08	\$8.07	\$8.35	0.00%	0.00%	0.00%	0.00%	\$8.35	\$8.35	30.35				
7A	Mounting Tube assembly	104-K070-01-16	1	Liner Weld Front to Valve	T1 Assembly/ Markup Applied @ BOM	Not Applicable	Electromechanical Assembly	Mech Assembly, MC Base	514	1	2	0.000	\$8.00	\$17.35	\$38.80	\$8.08	\$8.07	\$8.35	0.00%	0.00%	0.00%	0.00%	\$8.35	\$8.35	30.35					
<p>SECTION B</p> <p>Purchase Part - High Impact Item (Full Cost Mapping)</p>																														
1A	Body Injector Solenoid	104-K070-01-20	1	Machine Body	T2/T3 CNC Turning, MS&C	S-Steel-4102, Bar	CNC Operator	CNC Turning, MC	599	0.5	1	1	0.140	\$4.56	\$33.70	\$64.80	\$22.99	\$8.04	\$8.45	\$1.28	0.00%	0.00%	0.00%	0.00%	\$1.28	\$1.28	31.28			
2A	Shims wiring to inlet spoolator	104-K070-01-27	1	Machine and Rd. Spine	T2/T3 CNC Turning, MS&C	S-Steel-4102, Bar	CNC Operator	CNC Turning, MC	491	0.5	4.5	1	0.074	\$4.56	\$33.70	\$64.80	\$22.99	\$8.04	\$8.41	\$8.99	0.00%	0.00%	0.00%	0.00%	\$8.99	\$8.99	30.99			
3A	Shims Fuel Inlet	104-K070-01-28	1	Machine	T2/T3 CNC Turning, MS&C	S-Steel-4102, Bar	CNC Operator	CNC Turning, MC	485	0.5	3.5	1	0.041	\$4.56	\$33.70	\$64.80	\$22.99	\$8.04	\$8.33	\$8.95	0.00%	0.00%	0.00%	0.00%	\$8.95	\$8.95	30.95			
4A	Body needle	104-K070-01-9	1	Machine and Rd. Spine	T2/T3 CNC Turning, MS&C	S-Steel-4102, Bar	CNC Operator	CNC Turning, MC	469	0.5	5.5	1	0.243	\$4.56	\$33.70	\$64.80	\$22.99	\$8.04	\$8.54	\$9.27	0.00%	0.00%	0.00%	0.00%	\$9.27	\$9.27	30.27			
5A	Inlet Tube	104-K070-01-21	1	Cut and File	Forging Operator	Not Applicable	Forging Operator	Cold Chg. Inlet Tube	389	0.5	1	1	0.010	\$1.65	\$33.70	\$39.80	\$39.80	\$8.08	\$8.28	\$8.35	0.00%	0.00%	0.00%	0.00%	\$8.35	\$8.35	30.35			
6A	Shims Solenoid	104-K070-01-14	1	Solenoid and Rd. Spine	T2/T3 CNC Turning, MS&C	S-Steel-4102, Bar	CNC Operator	CNC Turning, MC	549	0.5	1.5	1	0.030	\$8.00	\$17.35	\$68.80	\$8.08	\$8.13	\$8.44	0.00%	0.00%	0.00%	0.00%	\$8.44	\$8.44	30.44				
7A	Needle wire	104-K070-01-24	1	Schedule 80rd	T2/T3 CNC Turning, MS&C	Not Applicable	CNC Operator	CNC Turning, MC	549	0.5	1.1	1	0.030	\$8.00	\$17.35	\$68.80	\$8.78	\$8.08	\$8.92	0.00%	0.00%	0.00%	0.00%	\$8.92	\$8.92	30.92				
<p>SECTION C</p> <p>Purchase Part - Low Impact Item (Partial Cost Mapping = Processed Raw Material Estimate + Actual Component Assembly Process)</p>																														
<p>SECTION D</p> <p>Purchase Part - Commodity (Value taken from Purchase Part Database)</p>																														
1A	Solenoid Windings	104-K070-01-22	1	Winding	5																									
2A	Ring wiring solenoid	104-K070-01-26	1	Wiring	5																									
3A	Shims Needle Bar	104-K070-01-12	1	Shims	5																									
4A	Shims Needle Bar	104-K070-01-25	1	Shims	5																									
5A	Solenoid Shims	104-K070-01-46	1	Shims	5																									
6A	Shims Fuel Inlet	104-K070-01-18	1	Shims	5																									
7A	Inlet Solenoid Seal Washer	104-K070-01-15	1	Inlet Seal Washer	5																									
8A	Compression Filter - ring	104-K070-01-13	1	Filter	5																									

Figure G-1: Sample MAQS Costing Worksheet (Part 1 of 2)

MAQ'S Costing Assumptions																	
Process Information			Project/Ordering Pattern			Minimum Calculated Cycle Time				Project Process Requirement							
Days/Shift/Week	Hrs./Shift	Hrs./WK	Days/Week	Hrs./Day	Hrs./WK	Pcs./Hr. (100% Eff.)	Efficiency %	Cycle Time/Operation @ Stated Efficiency "Sec."	Lean Design Calculation for Complete Process Time "Sec."	Parallel Operations/Machine or Stations/Line	Piece/Cycle/Machine	Tack Time/Machine/Cycle "Seconds"	Multiplier, if Required for Parallel Processing (if Nothing)	Number of Equivalent Machines Required	Resulting Pieces/Hour	Resulting Cycle Time/Part "Sec."	Total Number of Direct Operators
<p>SECTION D</p> <p>Process & Equipment Assumptions</p> <p>Serial Automated Line with Operator load and unload. Shift, Operator load injector assembly w/face seal, SH2, install electric face seal, SH3 Press, Screen Stop and filter, SH4 Install Compression Limiter O-ring and O-ring Injector, SH5, Install Bracket Hold Down, SH 6 Face Seal, SH 7 Operator Unload & Rack</p> <p>Operator Load and Unload, Single Station, 1p seal install and size.</p> <p>Linear Transfer line feeding 2 Vertical Injection Presses. Both 4 Cavities (20). Linear Transfer Line, Shift Press Assembly (Electric Face Seal, SH3 Press, Screen Stop and filter, SH4 Install Compression Limiter O-ring and O-ring Injector, SH5, Install Bracket Hold Down, SH 6 Face Seal, SH 7 Operator Unload & Rack)</p> <p>Operator Load and Unload, Single Station, 1p seal install and size.</p> <p>Automated Rotary Laser weld table with operator load and unload. SH 1 & 2 load pallet, SH 3 Fixture & Weld, SH 4 Power/Weld, SH 5 Cool, SH 7 Reorientate, SH 8 Inset Valve Assembly/Spring and Sleeve, SH 9 Install Inlet Tube, SH 10 Blow Wash, SH 11 Cool, Station 12, Transfer Pallet.</p> <p>Serial automated load to pallet, automatic return and pass. Operator assistance on load and unload.</p> <p>Automated component feed and laser weld assembly station (load, in/out, clamp, weld, weight, unload)</p> <p>Automated component feed and laser weld assembly station (load, in/out, clamp, weld, weight, unload)</p>																	
<p>SECTION E</p> <p>PACKAGING CALCULATIONS:</p> <p>Packaging Type: Option #6: Tube 42, Tube/Pallet</p> <p>Part Size: 80x55x25mm</p> <p>Parts/Layer per Tube: 3 x 8</p> <p>Number of Layers per Tube: 9</p>																	
<p>SECTION F</p> <p>Supplier, Customer and In-House Inventory</p> <p>Supplier, Customer and In-House Inventory</p> <p>Number of Parts per Pallet/Rack</p> <p>Total Number of Pallets/Racks Required</p> <p>Cost per Pallet/Rack</p> <p>Supplier, Customer and In-House Inventory</p> <p>Supplier, Customer and In-House Inventory</p> <p>Number of Parts per Pallet/Rack</p> <p>Total Number of Pallets/Racks Required</p> <p>Cost per Pallet/Rack</p>																	

Figure G-2: Sample MAQS Costing Worksheet (Part 2 of 2)

OEM Operating Pattern (Weeks/Year):	47	OEM Plant Location:	North America
Annual Engine Volume (CPV):	450,000	Supplier Plant Location:	North America
Components per Engine:	4	OEM/T1 Classification:	T1 High Assembly Complexity
Annual Component Volume:	1,800,000	Shipping Method:	FOB Ship Point
Weekly Component Volume:	38,298	Packaging Specification:	Returnable Container & Internal Dunnage
Estimated Product Life:	10		

	Material	Labor	Burden	TMC	Scrap	SG&A	Profit	ED&T	Total Mark-up	TMC	
T1 or OEM Total Manufacturing Cost:	\$2.16	\$1.47	\$6.44	\$10.07	\$0.03	\$0.41	\$0.36	\$0.06	\$0.89		\$10.95
T1 or OEM Mark-Up Rates:	----	----	----	----	0.70%	7.00%	8.00%	4.00%	19.70%		
(SAC) T1 or OEM Mark-Up Values:	0.00	----	----	----	\$0.06	\$0.77	\$0.66	\$0.44	\$2.16		
Base Cost Impact to Vehicle:	\$2.16	\$1.47	\$6.44	\$10.07	\$0.11	\$1.16	\$1.26	\$0.50	\$3.05		\$13.11
										Packaging Cost:	\$0.01
										Net Cost Impact to Vehicle:	\$13.13

Figure G-3: Excerpt Illustrating Automated Link between OEM/T1 Classification Input in MAQS Worksheet and the Corresponding Mark-up Percentages Uploaded from the Mark-up Database

The “component quote level” identifies what level of detail is captured in the MAQS worksheet for a particular component/assembly, full quote, modification quote, or differential quote. When the “full quote” box is checked, it indicates all manufacturing costs are captured for the component/assembly. When the “modification quote” box is checked, it indicates only the changed portion of the component/assembly has been quoted. A differential quote is similar to a modification quote, with the exception that information from both technology configurations, is brought into the same MAQS worksheet, and a differential analysis is conducted on the input cost attributes versus the output cost attributes. For example, if two (2) brake boosters (e.g., HEV booster and baseline vehicle booster) are being compared for cost, each brake booster can have its differences quoted in a separate MAQS worksheet (modification quote) and the total cost outputs for each can be subtracted to acquire the differential cost. Alternatively, in a single MAQS worksheet, the cost driving attributes for the differences between the booster’s (e.g., mass difference on common components, purchase component differences, etc.) can be offset, and the differential cost calculated in a single worksheet. The differential quote method is typically employed those components with low differential cost impact to help minimize the number of MAQS worksheets generated.

From left to right, the MAQS worksheet is broken into two (2) main sections as the name suggests: a quote summary (*Section B*) and a manufacturing assumption section (*Section D*). The manufacturing assumption section, positioned to the right of the quote summary section, is where the additional assumptions and calculations are made to convert the serial processing operations from Lean Design® into mass production operations. Calculations made in this section are automatically loaded into the quote summary section. The quote summary section utilizes this data along with other costing database data to calculate the total cost for each defined operation in the MAQS worksheet.

Note “defined operations” are all the value-added operations required to make a component or assembly. For example, a high-pressure fuel injector may have twenty (20) base-level components which all need to be assembled together. To manufacture one (1) of the base-level components, there may be as many as two (2) or three (3) value-added process operations (e.g., cast, heat treat, machine). In the MAQS worksheet, each of these process operations has an individual line summarizing the manufacturing assumptions and costs for the defined operation. For a case with two (2) defined operations per base level component, plus two (2) subassembly and final assembly operations, there could be as many as forty (40) defined operations detailed out in the MAQS worksheet. For ease of viewing all the costs associated with a part, with multiple value-added operations, the operations are grouped together in the MAQS worksheet.

Commodity-based purchased parts are also included as a separate line code in the MAQS worksheet, although there are no supporting manufacturing assumptions and/or calculations required since the costs are provided as total costs.

From top to bottom, the MAQS worksheet is divided into four (4) quoting levels in which both the value-added operations and commodity-based purchase parts are grouped: (1) Tier 1 Supplier or OEM Processing and Assembly, (2) Purchase Part – High Impact Items, (3) Purchase Part – Low Impact Items, and (4) Purchase Part – Commodity. Each quoting level has different rules relative to what cost elements are applicable, how cost elements are binned, and how they are calculated.

Items listed in the ***Tier 1 Supplier or OEM Processing and Assembly*** section are all the assembly and subassembly manufacturing operations assumed to be performed at the main OEM or T1 manufacturing facility. Included in manufacturing operations would be any on-line attribute and/or variable product engineering characteristic checks. For this quote level, full and detailed cost analysis is performed (with the exception of mark-up which is applied to the TMC at the bottom of the worksheet).

Purchase Part – High Impact Items include all the operations assumed to be performed at Tier 2/3 (T2/3) supplier facilities and/or T1 internal supporting facilities. For this quote level, detailed cost analysis is performed, including mark-up calculations for those components/operations considered to be supplied by T2/3 facilities. T1 internal supporting facilities included in this category do not include mark-up calculations. As mentioned above, the T1 mark-up (for main and supporting facilities) is applied to the TMC at the bottom of the worksheet.

Purchase Part – Low Impact Items are for *higher priced* commodity-based items which need to have their manufacturing cost elements broken out and presented in the MAQS sheet similar to high impact purchase parts. If not, the material cost group in the MAQS worksheet may become distorted since commodity based purchase part costs are binned to material costs. ***Purchase Part – Commodity Parts*** are represented in the MAQS worksheet as a single cost and are binned to material costs.

At the bottom of the MAQS worksheet (*Section F*), all the value-added operations and commodity-based purchase part costs, recorded in the four (4) quote levels, are automatically added together to obtain the TMC. The applicable mark-up rates based on the T1 or OEM classification recorded in the MAQS header are then multiplied by the TMC to obtain the mark-up contribution. Adding the TMC and mark-up contribution together, a subtotal unit cost is calculated.

Important to note is that throughout the MAQS worksheet, all seven (7) cost element categories (material, labor, burden, scrap, SG&A, profit, and ED&T) are maintained in the analysis. *Section C*, MAQS breakout calculator, which resides between the quote summary and manufacturing assumption sections, exists primarily for this function.

The last major section of the MAQS worksheet is the packaging calculation, *Section E*. In this section of the MAQS worksheet a packaging cost contribution is calculated for each part based on considerations such as packaging requirements, pack densities, volume assumptions, stock, and/or transit lead times.

The sample packaging calculation (

Figure G-4) is taken from the high voltage traction battery subsystem (140301 Battery Module MAQS worksheet, EPA Case Study #N0502). In this example, a minimum of two (2) weeks of packaging are required to support inventory and transit lead times. This equates to packaging for 19,149 parts over the two (2) weeks, based off the weekly capacity planning rates. There are fifteen (15) pieces per pallet at a packaging hardware cost of \$575 per pallet (container and internal dunnage costs are from the Packaging Database). From this information, 1,277 pallet sets are required at \$575/set, totaling \$734,275 in packaging costs. Packaging is estimated to last thirty-six (36) months. Thus applying the amortization formula based on thirty-six (36) months, 5% interest, and 1.35 million parts/36 months yields \$0.585/part. This cost is added to the subtotal unit cost (TMC + mark-up) to obtain the Total Unit Cost.

Note that in this case both the container and dunnage are assumed returnable. Thus, the bottom section of the packaging calculator is not used.

PACKAGING CALCULATIONS:												
Packaging Type: Option#2 Part Size: 1000x 300 x 140 Parts/Layer: 3 Number of Layers: 5												
												
Packaging Cost per Piece	Total Amount	Lump Sum Payment (%)	Total # of Pieces	Number of Months	Interest Rate		Cost per Pallet/Rack	Total Number of Pallets/Racks Required	Number of Parts per Pallet/Rack	Supplier, Customer and In-transit Inventory Requirements (Months)	Supplier, Customer and In-transit Inventory Requirements (Parts)	Supplier, Customer and In-transit Inventory Requirements (Months)
Rack/Pallet Investment Amortization:	\$0.585	\$734,275	0.00%	1,350,000	36	5.00%	\$575	1277	15	2	19149	
Packaging Cost per Piece	Tier Pad Price Per	Tier Pads Pallet/Rack	Divider Pads, Price Per	Divider Pads Pallet/Rack	Other #1 Packaging Price Per	Other #1 Pads Pallet/Rack	Other #2 Packaging Price Per	Other #2 Pads Pallet/Rack	Other #3 Packaging Price Per	Other #3 Pads Pallet/Rack		
Expendable Packaging in Piece Cost:	\$0.00	\$0.00	0	\$0.00	0	\$0.00	0	\$0.00	0	\$0.00	0	
Packaging Cost Total:	\$0.585											

Figure G-4: Example of Packaging Cost Calculation for Base Battery Module

H. Glossary of Terms

Assembly: a group of interdependent components joined together to perform a defined function (e.g., turbocharger assembly, high pressure fuel pump assembly, high pressure fuel injector assembly).

Automatic Transmission (AT): is one type of motor vehicle transmission that can automatically change gear ratios as the vehicle moves, freeing the driver from having to shift gears manually.

BAS (Belt Alternator Starter): is a system design to start/re-start an engine using a non-traditional internal combustion engine (ICE) starter motor. In a standard internal ICE the crankshaft drives an alternator, through a belt pulley arrangement, producing electrical power for the vehicle. In the BAS system, the alternator is replaced with a starter motor/generator assembly so that it can perform opposing duties. When the ICE is running, the starter motor/generator functions as a generator producing electricity for the vehicle. When the ICE is off, the starter motor/generator can function as a starter motor, turning the crankshaft to start the engine. In addition to starting the ICE, the starter motor can also provide vehicle launch assist and regenerative braking capabilities.

Buy: the components or assemblies a manufacturer would purchase versus manufacture. All designated “buy” parts, within the analysis, only have a net component cost presented. These types of parts are typically considered commodity purchase parts having industry established pricing.

CBOM (Comparison Bill of Materials): a system bill of materials, identifying all the subsystems, assemblies, and components associated with the technology configurations under evaluation. The CBOM records all the high-level details of the technology configurations under study, identifies those items which have cost implication as a result of the new versus base technology differences, documents the study assumptions, and is the primary document for capturing input from the cross-functional team.

Component: the lowest level part within the cost analysis. An assembly is typically made up of several components acting together to perform a function (e.g., the turbine wheel in a turbocharger assembly). However, in some cases, a component can independently perform a function within a sub-subsystem or subsystem (e.g., exhaust manifold within the exhaust subsystem).

Cost Estimating Models: cost estimating tools, external to the Design Profit® software, used to calculate operation and process parameters for primary manufacturing processes (e.g., injection molding, die casting, metal stamping, forging). Key information calculated from the costing estimating tools (e.g., cycle times, raw material usage, equipment size) is inputted into the Lean Design® process maps supporting the cost analysis. The Excel base cost estimating models are developed and validated by Munro & Associates.

Costing Databases: the five core databases that contain all the cost rates for the analysis. (1) The **material database** lists all the materials used throughout the analysis along with the estimated price/pound for each; (2) The **labor database** captures various automotive, direct labor, manufacturing jobs (supplier and OEM), along with the associated mean hourly labor rates; (3) The **manufacturing overhead rate database** contains the cost/hour for the various pieces of manufacturing equipment assumed in the analysis; (4) A **mark-up database** assigns a percentage of mark-up for each of the four main mark-up categories (i.e., end-item scrap, SG&A, profit, and ED&T), based on the industry, supplier size, and complexity classification; (5) The **packaging database** contains packaging options and costs for each case.

Cross Functional Team (CFT): is a group of people with different functional expertise working toward a common goal.

Direct Labor (DIR): is the mean manufacturing labor wage directly associated with fabricating, finishing, and/or assembling a physical component or assembly.

Dual Clutch Transmission (DCT): is a differing type of semi-automatic or automated manual automotive transmission. It utilizes two separate clutches for odd and even gear sets. It can fundamentally be described as two separate manual transmissions (with their respective clutches) contained within one housing, and working as one unit. They are usually operated in a fully automatic mode, and many also have the ability to allow the driver to manually shift gears, albeit still carried out by the transmission's electro-hydraulics.

ED&T (engineering, design, and testing): is an acronym used in accounting to refer to engineering, design, and testing expenses.

Fringe (FR): are all the additional expenses a company must pay for an employee above and beyond base wage.

Fully Variable Valve Actuation (FVVA): is a generalized term used to describe any mechanism or method that can alter the shape or timing of a valve lift event within an internal combustion engine.

Gasoline Direct Inject (GDI): is a variant of fuel injection employed in modern two-stroke and four-stroke gasoline engines. The gasoline is highly pressurized, and injected via a common rail fuel line directly into the combustion chamber of each cylinder, as

opposed to conventional multi-point fuel injection that happens in the intake tract, or cylinder port.

Hybrid Electric Vehicle (HEV): is a type of hybrid vehicle and electric vehicle which combines a conventional internal combustion engine (ICE) propulsion system with an electric propulsion system.

Indirect Cost Multipliers (ICM): is developed by EPA to address the OEM indirect costs associated with manufacturing new components and assemblies. The indirect costs, costs associated with OEM research and development, corporate operations, dealership support, sales and marketing material, legal, and OEM owned tooling, are calculated by applying an ICM factor to the direct manufacturing cost.

Indirect Labor (IND): is the manufacturing labor indirectly associated with making a physical component or assembly.

Lean Design® (a module within the *Design Profit® software*): is used to create detailed process flow charts/process maps. Lean Design® uses a series of standardized symbols, with each base symbol representing a group of similar manufacturing procedures (e.g., fastening, material modifications, inspection). For each group, a Lean Design® library/database exists containing standardized operations along with the associated manufacturing information and specifications for each operation. The information and specifications are used to generate a net operation cycle time. Each operation on a process flow chart is represented by a base symbol, operation description, and operation time, all linked to a Lean Design® library/database.

Maintenance Repair (MRO): All actions which have the objective of retaining or restoring an item in or to a state in which it can perform its required function. The actions include the combination of all technical and corresponding administrative, managerial, and supervision actions

Make: terminology used to identify those components or assemblies a manufacturer would produce internally versus purchase. All parts designated as a “make” part, within the analysis, are costed in full detail.

MAQS (Manufacturing Assumption and Quote Summary) worksheet: standardized template used in the analysis to calculate the mass production manufacturing cost, including supplier mark-up, for each system, subsystem, and assembly quoted in the analysis. Every component and assembly costed in the analysis will have a MAQS worksheet. The worksheet is based on a standard OEM (original equipment manufacturer) quote sheet modified for improved costing transparency and flexibility in sensitivity studies. The main feeder documents to the MAQS worksheets are **process maps** and the **costing databases**.

MCRs (Material Cost Reductions): a process employed to identify and capture potential design and/or manufacturing optimization ideas with the hardware under evaluation. These savings could potentially reduce or increase the differential costs

between the new and base technology configurations, depending on whether an MCR idea is for the new or the base technology.

Naturally Aspirated (NA): is one common type of reciprocating piston internal combustion that depends solely on atmospheric pressure to counter the partial vacuum in the induction tract to draw in combustion air.

Net Component/Assembly Cost Impact to OEM: the net manufacturing cost impact per unit to the OEM for a defined component, assembly, subsystem, or system. For components produced by the supplier base, the net manufacturing cost impact to the OEM includes total manufacturing costs (material, labor, and manufacturing overhead), mark-up (end-item scrap costs, selling, general and administrative costs, profit, and engineering design and testing costs) and packaging costs. For OEM internally manufactured components, the net manufacturing cost impact to the OEM includes total manufacturing costs and packaging costs; mark-up costs are addressed through the application of an indirect cost multiplier.

NTAs (New Technology Advances): a process employed to identify and capture alternative advance technology ideas which could be substituted for some of the existing hardware under evaluation. These advanced technologies, through improved function and performance, and/or cost reductions, could help increase the overall value of the technology configuration.

Port Fuel Injected (PFI): is a method for admitting fuel into an internal combustion engine by fuel injector sprays into the port of the intake manifold.

Powertrain Package Proforma: a summary worksheet comparing the key physical and performance attributes of the technology under study with those of the corresponding base configuration.

Power-Split HEV: In a power-split hybrid electric drive train there are two motors: an electric motor and an internal combustion engine. The power from these two motors can be shared to drive the wheels via a power splitter, which is a simple planetary gear set.

Process Maps: detailed process flow charts used to capture the operations and processes and associated key manufacturing variables involved in manufacturing products at any level (e.g., vehicle, system, subsystem, assembly, and component).

P-VCSM (Powertrain–Vehicle Class Summary Matrix): records the technologies being evaluated, the applicable vehicle classes for each technology, and key parameters for vehicles or vehicle systems that have been selected to represent the new technology and baseline configurations in each vehicle class to be costed.

Quote: the analytical process of establishing a cost for a component or assembly.

SG&A (selling general and administrative): is an acronym used in accounting to refer to Selling, General and Administrative Expenses, which is a major non-production costs presented in an Income statement.

Sub-subsystem: a group of interdependent assemblies and/or components, required to create a functioning sub-subsystem. For example, the air induction subsystem contains several sub-subsystems including turbocharging, heat exchangers, pipes, hoses, and ducting.

Subsystem: a group of interdependent sub-subsystems, assemblies and/or components, required to create a functioning subsystem. For example, the engine system contains several subsystems including crank drive subsystem, cylinder block subsystem, cylinder head subsystem, fuel induction subsystem, and air induction subsystem.

Subsystem CMAT (Cost Model Analysis Templates): the document used to display and roll up all the sub-subsystem, assembly, and component incremental costs associated with a subsystem (e.g., fuel induction, air induction, exhaust), as defined by the Comparison Bill of Material (CBOM).

Surrogate part: a part similar in fit, form, and function as another part that is required for the cost analysis. Surrogate parts are sometimes used in the cost analysis when actual parts are unavailable. The surrogate part's cost is considered equivalent to the actual part's cost.

System: a group of interdependent subsystems, sub-subsystems, assemblies, and/or components working together to create a vehicle primary function (e.g., engine system, transmission system, brake system, fuel system, suspension system).

System CMAT (Cost Model Analysis Template): the document used to display and roll up all the subsystem incremental costs associated with a system (e.g., engine, transmission, steering) as defined by the CBOMs.